

# SCREW PLUG IMMERSION HEATERS

**ELECTRIC  
PROCESS HEATER  
SOLUTIONS  
BEGIN HERE...**



*Electric heaters are our only business.*

*We are specialists in designing, engineering, and manufacturing  
both standard and custom Electric Process Heaters.*

**WARREN ELECTRIC CORPORATION**

36 Franklin Street, PO Box 86, Warren, Rhode Island 02885-0086 USA

Toll Free: 1-877-399-HEAT (4328) Tel: 401-245-3700 Fax: 401-245-9331

Email: [wec@warrenonline.com](mailto:wec@warrenonline.com) [www.warrenonline.com](http://www.warrenonline.com)

**ISO 9001 REGISTERED**

**ASME ACCREDITED**



SP-101



# WARREN ELECTRIC CORPORATION

## ELECTRIC PROCESS HEATER SOLUTIONS BEGIN HERE!

*Warren Electric Corporation has over 40 years of experience in the design and manufacture of high-quality electric process heaters. This knowledge is put to work to provide long-lasting and trouble-free immersion heaters. We welcome and appreciate the opportunity to assist you with selecting, quoting, and supplying your electric heater requirements. **You will appreciate:***

- A wide selection of standard and custom **screw plug, flanged, circulation, and over-the-side** electric immersion heaters from a large parts inventory.
- **Prompt quotations and detailed order acknowledgements.**
- **Reliable** shipping schedule performance.
- Ease of expediting as our inventory and shipping schedules are monitored continuously by computer.
- **High Quality Products** at competitive pricing.
- **Custom** designs from standard parts.
- **Replacements** for most brands of electric immersion heaters.
- Prompt and individual attention to your particular heater needs.
- A 15 month warranty period.
- Terminal enclosures available in many different types for all applications including standard heavy-duty terminal enclosures to protect integral thermostats and electrical connections from hazards.

*The Quality Policy at Warren Electric Corporation, throughout the organization, is to meet or exceed the expectations of our customers, satisfy our obligations to the standards for which we are accredited, and to continuously strive for excellence.*

**STANDARD  
OR  
CUSTOM  
HEATERS.**

**QUALITY  
HEATERS  
FOR  
TROUBLE-  
FREE  
OPERATION.**

### Quality Commitment

Warren Electric Corporation heaters must pass vigorous inspections prior to shipment. Each individual heating element is checked for electrical leakage and breakdown at high voltage before assembly.

All heaters are 100% hydrostatically pressure tested to insure braze or weld attaching the element to the screw plug is free of all leaks. We also electrically test 100% of heaters to ensure they meet the wattage/voltage specifications of the order. 100% of our heaters are also subject to testing for moisture content and hipot testing.

Every heater that Warren Electric Corporation has ever manufactured is identified with a serial number prior to shipment. These serial numbers are kept on file indefinitely and can be used to identify back to the original inspection sheet and purchase order.

Third party certifications and inspections, as described on the back cover of this catalog, including UL and ISO, and over 40 years of manufacturing excellence makes Warren Electric Corporation the quality manufacturer and supplier of choice for QUALITY ELECTRIC IMMERSION HEATERS.

**WHAT YOU  
NEED.  
WHEN YOU  
NEED IT.**

**HELP FROM  
PEOPLE  
WHO KNOW  
HEATERS  
INSIDE AND  
OUT.**

***How to Order,  
PLEASE:***

- Call the "HEAT SOURCE" Hot Line: **1-877-399-HEAT (4328) Toll Free**
- Fax Us: **1-401-245-9331**
- Email Us: **wec@warrenonline.com**
- Download a WEC "Quick Quote" form at [www.warrenonline.com](http://www.warrenonline.com)
- Online Fill out a "Quick Quote" Online



**SCREW PLUG HEATER CATALOG  
TABLE OF CONTENTS**

**Introduction**

About WEC ----- Page 2  
 Table of Contents ----- Page 3  
 About Screw Plug Heaters ----- Pages 4-6

**Screw Plug Immersion Heaters**

**Copper Sheathed Elements ----- Pages 7-9**  
 1" and 1¼" NPT ----- Page 7      2" NPT ----- Page 8  
 2½" NPT ----- Page 9      3" NPT ----- Page 9

**Steel Sheathed Elements ----- 6 - 11 WSI ----- Pages 10-11**  
 2" NPT ----- Page 10      2½" and 3" NPT - Page 11

**Steel Sheathed Elements ----- 16 - 17 WSI ----- Pages 12-13**  
 2" NPT ----- Page 12      2½" and 3" NPT - Page 13

**Steel Sheathed Elements ----- 23 - 27 WSI ----- Pages 14-16**  
 1" and 1¼" NPT ----- Page 14      2" NPT ----- Pages 15  
 2½" and 3" NPT ----- Page 16

**Incoloy Sheathed Elements ----- 16 - 17 WSI ----- Pages 17-18**  
 2" NPT ----- Page 17      2½" and 3" NPT - Page 18

**Incoloy Sheathed Elements ----- 22 - 24 WSI ----- Pages 19-21**  
 1" and 1¼" NPT ----- Page 19      2" NPT ----- Page 20  
 2½" and 3" NPT ----- Page 21

**Incoloy Sheathed Elements ----- 47 - 55 WSI ----- Pages 22-23**  
 2" NPT ----- Page 22      2½" and 3" NPT - Page 23

**Stainless Steel Sheathed Elements 47-55 WSI ----- Pages 24-25**  
 2" NPT ----- Page 24      2½" and 3" NPT - Page 25

**Misc.**

Thermostat/Thermowell Information ..... Page 26  
 Thermocouples, RTD's ..... Page 26  
 Casings ..... Page 27  
 Terminal Enclosures ..... Pages 28-29  
 Model Designation ..... Page 30  
 Screw Plug Heater "Quick Quote" ..... Page 31  
 Certifications and Compliances ..... Back Cover

*Whether it be STANDARD or CUSTOM,  
 a REPLACEMENT or NEW DESIGN...  
 please turn to us for COMPETITIVE PRICING and QUICK DELIVERY  
 on your next Electric Heater application.*



# Screw Plug Immersion Heaters

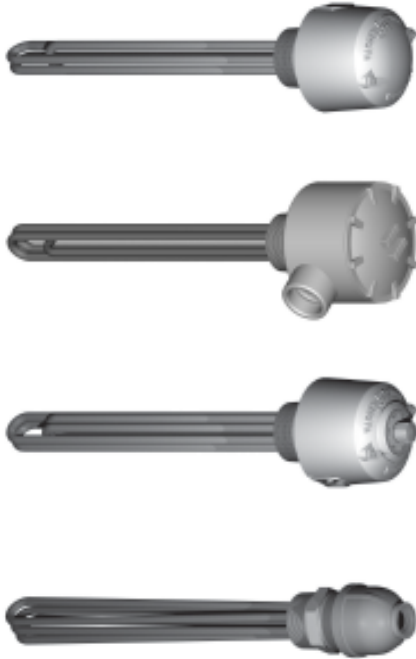

## Standard Features

Warren Electric Corporation has been manufacturing **QUALITY Industrial Screw Plug Electric Heaters** since 1962. WEC Screw Plug Heaters consist of tubular elements that are brazed or welded to a screw plug and provided with or without Thermostat, and with Terminal Enclosures suited for your application.

Screw Plug sizes up to 3" NPT in Brass, Bronze, Carbon, and Stainless Steels are available. Screw Plug Heaters are screwed directly into a tank wall or through a matching pipe coupling.

**Terminal Enclosures** are either general purpose, weather and/or explosion resistant. The selection of terminal enclosure should be determined by the most extreme operating environment at the heater terminal area. For more information, please turn to pages 36-37 in this catalog.

Most heaters listed in this catalog are available with or without **Thermostats, Thermocouples, and/or RTD's**. Information is located on page 26 of this catalog or consult factory.

*We are dedicated to meeting and exceeding the needs and expectations of our customers for **INNOVATIVE and RELIABLE** heating solutions.*

<b>Screw Plug Heater Specifications:</b>	• <b>Wattage:</b>	0.25 to 100 kilowatts
	• <b>Voltage:</b>	Up to 600 volts, Single or 3 phase
	• <b>Screw plug size:</b>	1" to 3" NPT
	• <b>Pressure rating:</b>	Up to 300 PSIG
	• <b>Screw Plug Material:</b>	Carbon Steel, Various Stainless Steels, Brass, Bronze
	• <b>Immersed length:</b>	Up to 130 inches
	• <b>Sheath Materials:</b>	Steel, Copper, Stainless Steel(s), and Incoloy

*Our Applications Engineers and Technical Sales people are available to assist you. Please call our toll free "Heat Source" Hotline 1-877-399-HEAT (4328) or email us.*

<b>Features/Options</b> that are available in the manufacture of WEC Screw Plug Heaters include:	
• Element Sheath Materials	• Passivation or Electropolishing
• Screw Plug Materials	• High-Temperature Applications
• Welded or Brazed Construction	• Thermostats, Thermocouples, RTD's, etc...
• Temperature Control Options	• UL listing
• Terminal Enclosures	• ASME Certification
• Element Supports and Baffles	• CE Conformance for Export
• Compact Designs	• Immersion lengths to meet your WSI requirements
• Multiple Circuits	• Casings & Assemblies with options of your choice
• Thermowell standard	• Ground lug standard to insure NEC requirements



# Screw Plug Immersion Heaters

## Applications

Typical applications for Screw Plug Heaters include, but are not limited to, process water heating, freeze protection, and the heating of oils, and heat transfer mediums. Warren Electric Corporation Screw Plug Immersion Heaters are used to heat:

- Water: Clean, Potable, Deionized, Process, Demineralized
- Oils: Asphalt, Fuels, Cooking, Heat Transfer, Crude, Hydraulic
- Lubricating oils at API specified watt densities
- Mild acids
- Freeze Protection
- Industrial water rinse tanks
- Vapor degreasers
- Degreasing solutions
- Air and gas flow
- Caustic solutions
- Chemical baths
- Anti-freeze (glycol) solutions
- Paraffin or wax
- Electroplating
- ...and more!

## Heater Selection

Heater selection determination includes a lot of factors including:

1. Final temperature desired.
2. Medium being heated, all specifications including corrosiveness, heat density.
3. Watt Density allowed.
4. Sheath Material required.
5. Screw Plug Material required.
6. Power Requirements.
7. Heater environment for Terminal Enclosure determination.
8. Maximum length and/or size restrictions.

For assistance on your heater selection and/or power requirements, please refer to our Screw Plug "Quick Quote" Form on the back inside cover of this catalog or call our technical staff for assistance.

## Typical Installation

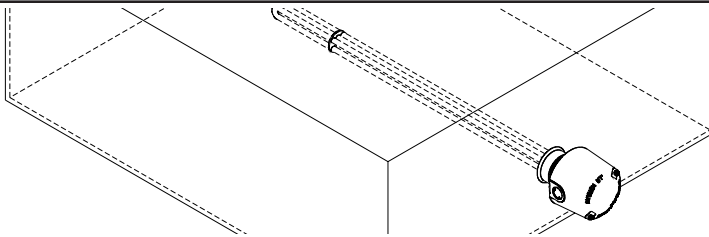

The heated portion of the heater elements must remain completely immersed and completely flooded whenever energized. The cold section of the heater should be extended completely into the fluid being heated. The heater may overheat, damage the elements, tank, or fluid being heated, and/or create a possible safety hazard due to high sheath temperatures.

## Elements

Tubular heating elements are constructed using only the highest quality component materials. The outer metal sheath material used is determined by the specific application. Warren Electric Corporation uses only high purity magnesium oxide insulation to insure good dielectric resistance between the resistance wire and the outer metal sheath.

The internal nichrome resistance wire is carefully selected and coiled to meet stringent design criteria based upon individual heater specifications.

The resistance wire is coiled and then welded to a terminal pin to assure positive connection. The coil is then centered in the metal sheath and insulated with the highest quality magnesium oxide which is then highly compacted and acts as an electrical insulator.

The elements are bent in a U-bend configuration and the U-bends are repressed to remove air gaps which ensure good dielectric strength.

Each individual heating element is checked for electrical leakage and breakdown at high voltage before assembly.

Standard **sheath materials** available are: Copper, Steel, Stainless 321, Stainless 316L, and Incoloy 840. Sheath selection is determined by the user's knowledge of the chemical composition of the medium being heated, corrosiveness, contaminants, and controls.





# Screw Plug Immersion Heaters

## 1" NPT Plug

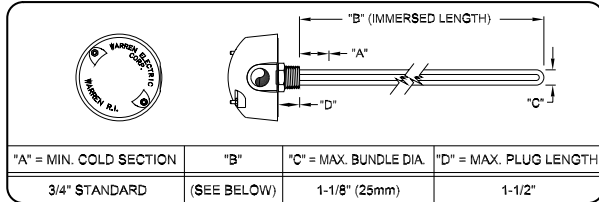

## 1 1/4" NPT Plug

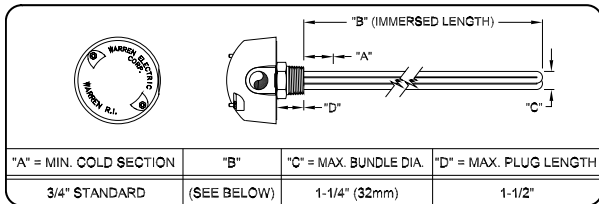

## 2" NPT Plug

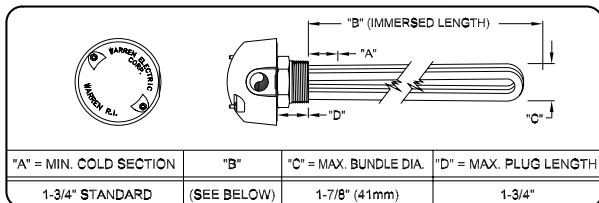

## 2 1/2" NPT Plug

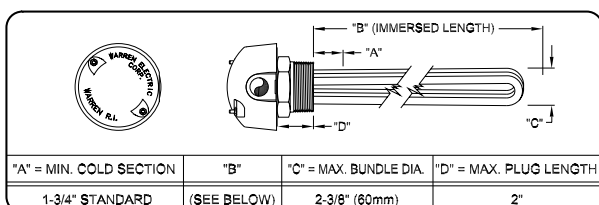

## 3" NPT Plug

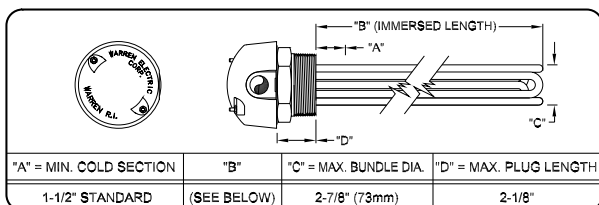

**Specifications and dimensions are subject to change. Consult Factory.**

## Thermostats/RTD

Models listed on these pages are available with or without thermostats, (various temperature ranges), thermocouples, or RTD's. A thermowell is standard in the design of the heaters listed in this catalog to allow for a thermostat/temperature sensing device. To add a thermostat with a 60° - 250° F range, replace X in model number with 2-. A heater ordered with a thermostat will be supplied with a high profile terminal enclosure.

For detailed information, please refer to Thermostats, Thermocouples, & RTD's on page 26.

## Terminal Enclosures

Heavy duty general purpose terminal enclosures are standard with Warren Electric Corporation Screw Plug Heaters. Warren Electric's general purpose terminal enclosure provides superior mechanical protection for your heater's wiring, terminals, and thermostat.

Our general purpose terminal enclosure is constructed from heavy gauge cast aluminum, as opposed to a drawn "tin can" style often seen with other brands.

Models listed in this catalog are without thermostats and have low profile terminal enclosures, but all models listed on these pages are available with various terminal enclosures including Economy, General Purpose, Weather and/or Explosion-Resistant. For dimensional and information on other terminal enclosures, see Terminal Enclosures section on pages 28-29.



**Screw Plug Heaters - Copper Sheathed Elements**

**Typical Applications for  
Copper Sheathed Elements**

- Clean Water
- Freeze Protection of Aqueous Solutions
- Other Aqueous Solutions not corrosive to Copper Sheath.

The models listed on these pages do not have thermostats, but are available with thermostats. A thermowell is standard in the design of the heaters listed in this catalog to allow for a thermostat/temperature sensing device.

To add a thermostat with a 60° - 250° F range, replace: **X** in model number with **2-**. A heater ordered with a thermostat will be supplied with a high profile terminal enclosure.

**Copper Sheathed Elements**

**1" NPT  
BRASS Plug**

**0.5 to 4 kW  
55-99 W/in<sup>2</sup>**

**U.L. Listed**

**120, 208, & 240 Volt, Single Phase**

kW	Immersion		Watt Density		120V	208V	240V	No. Ele	Est Weight	
	in	(mm)	W/in <sup>2</sup>	(W/cm <sup>2</sup> )	1 Phase	1 Phase	1 Phase		lb	(kg)
0.5	5.5	(140)	55	(8.5)	XFS-.5-1-5.5C	XFS-.5-208-5.5C	XFS-.5-2-5.5C	1	3	(2)
0.75	6.75	(172)	63	(9.8)	XFS-.75-1-6.75C	XFS-.75-208-6.75C	XFS-.75-2-6.75C	1	3	(2)
1	6.75	(172)	84	(13)	XFS-1-1-6.75C	XFS-1-208-6.75C	XFS-1-2-6.75C	1	3	(2)
1.5	9.5	(242)	88	(13.6)	XFS-1.5-1-9.5C	XFS-1.5-208-9.5C	XFS-1.5-2-9.5C	1	3	(2)
2	12.5	(318)	86	(13.3)	XFS-2-1-12.5C	XFS-2-208-12.5C	XFS-2-2-12.5C	1	3	(2)
2.5	15	(381)	89	(13.8)	XFS-2.5-1-15C	XFS-2.5-208-15C	XFS-2.5-2-15C	1	3	(2)
3	17	(432)	93	(14.4)	XFS-3-1-17C	XFS-3-208-17C	XFS-3-2-17C	1	3	(2)
4	21	(534)	99	(15.3)	XFS-4-1-21C	XFS-4-208-21C	XFS-4-2-21C	1	4	(2)

**1 1/4" NPT  
BRASS Plug**

**0.5 to 6 kW  
55-93 W/in<sup>2</sup>**

**U.L. Listed**

**120, 208, 240, & 480 Volt, Single Phase**

kW	Immersion		Watt Density		120V	208V	240V	480V	No. Ele	Est Weight	
	in	(mm)	W/in <sup>2</sup>	(W/cm <sup>2</sup> )	1 Phase	1 Phase	1 Phase	1 Phase		lb	(kg)
0.5	5.5	(140)	55	(8.5)	XGS-.5-1-5.5C	XGS-.5-208-5.5C	XGS-.5-2-5.5C		1	3	(2)
0.75	6.5	(166)	63	(9.8)	XGS-.75-1-6.5C	XGS-.75-208-6.5C	XGS-.75-2-6.5C		1	3	(2)
1	5.5	(140)	55	(8.5)	XGS-1-1-5.5C	XGS-1-208-5.5C	XGS-1-2-5.5C		2	3	(2)
1.5	6.5	(166)	68	(10.5)	XGS-1.5-1-6.5C	XGS-1.5-208-6.5C	XGS-1.5-2-6.5C	XGS-1.5-4-6.5C	2	4	(2)
2	6.5	(166)	84	(13)	XGS-2-1-6.5C	XGS-2-208-6.5C	XGS-2-2-6.5C	XGS-2-4-6.5C	2	4	(2)
2.5	10.5	(267)	65	(10.1)	XGS-2.5-1-10.5C	XGS-2.5-208-10.5C	XGS-2.5-2-10.5C	XGS-2.5-4-10.5C	2	4	(2)
3	9.5	(242)	88	(13.6)	XGS-3-1-9.5C	XGS-3-208-9.5C	XGS-3-2-9.5C	XGS-3-4-9.5C	2	4	(2)
3	12	(305)	68	(10.5)	XGS-3-1-12C	XGS-3-208-12C	XGS-3-2-12C	XGS-3-4-12C	2	4	(2)
4	12.5	(318)	86	(13.3)	XGS-4-1-12.5C	XGS-4-208-12.5C	XGS-4-2-12.5C	XGS-4-4-12.5C	2	4	(2)
4	15	(381)	70	(10.9)	XGS-4-1-15C	XGS-4-208-15C	XGS-4-2-15C	XGS-4-4-15C	2	5	(3)
5	15	(381)	89	(13.8)	XGS-5-1-15C	XGS-5-208-15C	XGS-5-2-15C	XGS-5-4-15C	2	4	(2)
5	18.5	(470)	70	(10.9)	XGS-5-1-18.5C	XGS-5-208-18.5C	XGS-5-2-18.5C	XGS-5-4-18.5C	2	5	(3)
6	17	(432)	93	(14.4)	XGS-6-1-17C	XGS-6-208-17C	XGS-6-2-17C	XGS-6-4-17C	2	5	(3)
6	21	(534)	74	(11.5)	XGS-6-1-21C	XGS-6-208-21C	XGS-6-2-21C	XGS-6-4-21C	2	5	(3)



## Screw Plug Heaters - Copper Sheathed Elements

**2" NPT  
BRONZE Plug**

**1.5 to 18 kW  
56-67 W/in<sup>2</sup>**

**120 Volt, Single Phase  
& 208 Volt, Single & Three Phase**

**U.L. Listed**

kW	Immersion		Watt Density		120V	208V	208V	No. Ele	Est Weight	
	in	(mm)	W/in <sup>2</sup>	(W/cm <sup>2</sup> )	1 Phase	1 Phase	3 Phase		lb	(kg)
1.5	11	(280)	61	(9.5)	XPS-1.5-1-11C	XPS-1.5-208-11C		1	4	(2)
2	8	(204)	61	(9.5)	XPS-2-1-8C	XPS-2-208-8C		2	4	(2)
2.5	9.5	(242)	58	(9)	XPS-2.5-1-9.5C	XPS-2.5-208-9.5C		2	5	(3)
3	8	(204)	61	(9.5)	XPS-3-1-8C	XPS-3-208-8C	XPS-3-208-8C*3	3	5	(3)
3	11	(280)	61	(9.5)	XPS-3-1-11C	XPS-3-208-11C		2	5	(3)
4	15	(381)	56	(8.7)	XPS-4-1-15C	XPS-4-208-15C		2	5	(3)
4.5	11	(280)	61	(9.5)	XPS-4.5-1-11C	XPS-4.5-208-11C	XPS-4.5-208-11C*3	3	5	(3)
5	18	(458)	57	(8.8)	XPS-5-1-18C	XPS-5-208-18C		2	5	(3)
6	15	(381)	56	(8.7)		XPS-6-208-15C	XPS-6-208-15C*3	3	6	(3)
6	21	(534)	58	(9)		XPS-6-208-21C		2	6	(3)
7	25	(635)	60	(9.3)		XPS-7-208-25C		2	6	(3)
7.5	18	(458)	57	(8.8)		XPS-7.5-208-18C	XPS-7.5-208-18C*3	3	6	(3)
8	27	(686)	61	(9.5)		XPS-8-208-27C		2	6	(3)
9	21	(534)	58	(9)		XPS-9-208-21C	XPS-9-208-21C*3	3	7	(4)
10	32	(813)	61	(9.5)		XPS-10-208-32C		2	7	(4)
12	27	(686)	61	(9.5)			XPS-12-208-27C*3	3	8	(4)
15	32	(813)	61	(9.5)			XPS-15-208-32C*3	3	9	(5)

### 240 & 480 Volt, Single & Three Phase

kW	Immersion		Watt Density		240V	240V	480V	480V	No. Ele	Est Weight	
	in	(mm)	W/in <sup>2</sup>	(W/cm <sup>2</sup> )	1 Phase	3 Phase	1 Phase	3 Phase		lb	(kg)
1.5	11	(280)	61	(9.5)	XPS-1.5-2-11C		XPS-1.5-4-11C		1	4	(2)
2	8	(204)	61	(9.5)	XPS-2-2-8C		XPS-2-4-8C		2	4	(2)
2.5	9.5	(242)	58	(9)	XPS-2.5-2-9.5C		XPS-2.5-4-9.5C		2	5	(3)
3	8	(204)	61	(9.5)	XPS-3-2-8C	XPS-3-2-8C*3	XPS-3-4-8C	XPS-3-4-8C*3	3	5	(3)
3	11	(280)	61	(9.5)	XPS-3-2-11C		XPS-3-4-11C		2	5	(3)
4	15	(381)	56	(8.7)	XPS-4-2-15C		XPS-4-4-15C		2	5	(3)
4.5	11	(280)	61	(9.5)	XPS-4.5-2-11C	XPS-4.5-2-11C*3	XPS-4.5-4-11C	XPS-4.5-4-11C*3	3	5	(3)
5	18	(458)	57	(8.8)	XPS-5-2-18C		XPS-5-4-18C		2	5	(3)
6	15	(381)	56	(8.7)	XPS-6-2-15C	XPS-6-2-15C*3	XPS-6-4-15C	XPS-6-4-15C*3	3	6	(3)
6	21	(534)	58	(9)	XPS-6-2-21C		XPS-6-4-21C		2	6	(3)
7	25	(635)	60	(9.3)	XPS-7-2-25C		XPS-7-4-25C		2	6	(3)
7.5	18	(458)	57	(8.8)	XPS-7.5-2-18C	XPS-7.5-2-18C*3	XPS-7.5-4-18C	XPS-7.5-4-18C*3	3	6	(3)
8	27	(686)	61	(9.5)	XPS-8-2-27C		XPS-8-4-27C		2	6	(3)
9	21	(534)	58	(9)	XPS-9-2-21C	XPS-9-2-21C*3	XPS-9-4-21C	XPS-9-4-21C*3	3	7	(4)
10	32	(813)	61	(9.5)	XPS-10-2-32C		XPS-10-4-32C		2	7	(4)
12	27	(686)	61	(9.5)		XPS-12-2-27C*3	XPS-12-4-27C	XPS-12-4-27C*3	3	8	(4)
12	38	(966)	67	(10.4)	XPS-12-2-38C+2		XPS-12-4-38C		2	7	(4)
15	32	(813)	61	(9.5)		XPS-15-2-32C*3	XPS-15-4-32C	XPS-15-4-32C*3	3	9	(5)
18	38	(966)	67	(10.4)		XPS-18-2-38C*3	XPS-18-4-38C	XPS-18-4-38C*3	3	9	(5)

For models or options not listed, please refer to our "Quick Quote" on the back inside cover or consult factory.

To place your order or for technical support, please call TOLL FREE 877-399-HEAT (4328) or FAX 401-245-9331





**Screw Plug Heaters - Copper Sheathed Elements**

**2 1/2" NPT BRONZE Plug**      **3 to 18 kW**      **56-61 W/in<sup>2</sup>**      **120 Volt, Single Phase & 208 Volt, Single & Three Phase**      **U.L. Listed**

kW	Immersion		Watt Density		120V	208V	208V	No. Ele	Est Weight	
	in	(mm)	W/in <sup>2</sup>	(W/cm <sup>2</sup> )	1 Phase	1 Phase	3 Phase		lb	(kg)
3	8	(204)	61	(9.5)	XRS-3-1-8C	XRS-3-208-8C	XRS-3-208-8C*3	3	5	(3)
4.5	11	(280)	61	(9.5)	XRS-4.5-1-11C	XRS-4.5-208-11C	XRS-4.5-208-11C*3	3	6	(3)
6	15	(381)	56	(8.7)		XRS-6-208-15C	XRS-6-208-15C*3	3	6	(3)
7.5	18	(458)	57	(8.8)		XRS-7.5-208-18C	XRS-7.5-208-18C*3	3	7	(4)
9	21	(534)	58	(9)		XRS-9-208-21C	XRS-9-208-21C*3	3	7	(4)
12	27	(686)	61	(9.5)			XRS-12-208-27C*3	3	8	(4)
15	32	(813)	61	(9.5)			XRS-15-208-32C*3	3	9	(5)

**240 & 480 Volt, Single & Three Phase**

kW	Immersion		Watt Density		240V	240V	480V	480V	No. Ele	Est Weight	
	in	(mm)	W/in <sup>2</sup>	(W/cm <sup>2</sup> )	1 Phase	3 Phase	1 Phase	3 Phase		lb	(kg)
3	8	(204)	61	(9.5)	XRS-3-2-8C	XRS-3-2-8C*3	XRS-3-4-8C	XRS-3-4-8C*3	3	5	(3)
4.5	11	(280)	61	(9.5)	XRS-4.5-2-11C	XRS-4.5-2-11C*3	XRS-4.5-4-11C	XRS-4.5-4-11C*3	3	6	(3)
6	15	(381)	56	(8.7)	XRS-6-2-15C	XRS-6-2-15C*3	XRS-6-4-15C	XRS-6-4-15C*3	3	6	(3)
7.5	18	(458)	57	(8.8)	XRS-7.5-2-18C	XRS-7.5-2-18C*3	XRS-7.5-4-18C	XRS-7.5-4-18C*3	3	7	(4)
9	21	(534)	58	(9)	XRS-9-2-21C	XRS-9-2-21C*3	XRS-9-4-21C	XRS-9-4-21C*3	3	7	(4)
12	27	(686)	61	(9.5)		XRS-12-2-27C*3	XRS-12-4-27C	XRS-12-4-27C*3	3	8	(4)
15	32	(813)	61	(9.5)		XRS-15-2-32C*3	XRS-15-4-32C	XRS-15-4-32C*3	3	9	(5)
18	38	(966)	67	(10.4)		XRS-18-2-38C*3	XRS-18-4-38C	XRS-18-4-38C*3	3	10	(5)

**3" NPT STEEL Plug**      **6 to 36 kW**      **56-61 W/in<sup>2</sup>**      **120 Volt, Single Phase & 208 Volt, Single & Three Phase**      **U.L. Listed**

kW	Immersion		Watt Density		120V	208V	208V	No. Ele	Est Weight	
	in	(mm)	W/in <sup>2</sup>	(W/cm <sup>2</sup> )	1 Phase	1 Phase	3 Phase		lb	(kg)
6	8	(204)	61	(9.5)	XCS-6-1-8C+2	XCS-6-208-8C	XCS-6-208-8C*3	6	10	(5)
9	11	(280)	61	(9.5)	XCS-9-1-11C+2	XCS-9-208-11C	XCS-9-208-11C*3	6	11	(5)
12	15	(381)	56	(8.7)		XCS-12-208-15C+2	XCS-12-208-15C*3	6	12	(6)
15	18	(458)	57	(8.8)		XCS-15-208-18C+2	XCS-15-208-18C*3	6	13	(6)
18	21	(534)	58	(9)		XCS-18-208-21C+2	XCS-18-208-21C*3+2	6	14	(7)
24	26	(661)	61	(9.5)			XCS-24-208-26C*3+2	6	15	(7)
30	32	(813)	61	(9.5)			XCS-30-208-32C*3+2	6	17	(8)

**240 & 480 Volt, Single & Three Phase**

kW	Immersion		Watt Density		240V	240V	480V	480V	No. Ele	Est Weight	
	in	(mm)	W/in <sup>2</sup>	(W/cm <sup>2</sup> )	1 Phase	3 Phase	1 Phase	3 Phase		lb	(kg)
6	8	(204)	61	(9.5)	XCS-6-2-8C	XCS-6-2-8C*3	XCS-6-4-8C	XCS-6-4-8C*3	6	10	(5)
9	11	(280)	61	(9.5)	XCS-9-2-11C	XCS-9-2-11C*3	XCS-9-4-11C	XCS-9-4-11C*3	6	11	(5)
12	15	(381)	56	(8.7)	XCS-12-2-15C	XCS-12-2-15C*3	XCS-12-4-15C	XCS-12-4-15C*3	6	12	(6)
15	18	(458)	57	(8.8)	XCS-15-2-18C+2	XCS-15-2-18C*3	XCS-15-4-18C	XCS-15-4-18C*3	6	13	(6)
18	21	(534)	58	(9)	XCS-18-2-21C+2	XCS-18-2-21C*3	XCS-18-4-21C	XCS-18-4-21C*3	6	14	(7)
24	26	(661)	61	(9.5)	XCS-24-2-26C+2	XCS-24-2-26C*3+2	XCS-24-4-26C+2	XCS-24-4-26C*3	6	15	(7)
30	32	(813)	61	(9.5)		XCS-30-2-32C*3+2	XCS-30-4-32C+2	XCS-30-4-32C*3	6	17	(8)
36	38	(966)	67	(10.4)		XCS-36-2-38C*3+2	XCS-36-4-38C+2	XCS-36-4-38C*3	6	19	(9)

For models or options not listed, please refer to our "Quick Quote" on the back inside cover or consult factory.

To place your order or for technical support, please call TOLL FREE 877-399-HEAT (4328) or FAX 401-245-9331

Copper Sheathed Elements



**Screw Plug Heaters - Steel Sheathed Elements**

**Typical Applications for  
Steel Sheathed Elements  
6-11 WSI**

- Residual Fuel Oils (Bunker C and #6)
- Asphalt
- Heavy Weight Lubrication Oils
- Static Heat Transfer Oils
- Hydraulic Fluids

The models listed on these pages do not have thermostats, but are available with thermostats. A thermowell is standard in the design of the heaters listed in this catalog to allow for a thermostat/temperature sensing device.

To add a thermostat with a 0° - 100° F range, replace: **X** in model number with **1-**. A heater ordered with a thermostat will be supplied with a high profile terminal enclosure.

**2" NPT  
STEEL Plug**

**0.5 to 5 kW  
6-11 W/in<sup>2</sup>**

**Low Watt Density 6-11 WSI  
120 Volt, Single Phase  
& 208 Volt, Single & Three Phase**

kW	Immersion		Watt Density		120V	208V	208V	No. Ele	Est Weight	
	in	(mm)	W/in <sup>2</sup>	(W/cm <sup>2</sup> )	1 Phase	1 Phase	3 Phase		lb	(kg)
0.5	12	(305)	9	(1.4)	XPS-.5-1-12	XPS-.5-208-12		2	5	(3)
0.5	12	(305)	6	(0.9)			XPS-.5-208-12*3	3	6	(3)
1	18	(458)	8	(1.2)	XPS-1-1-18	XPS-1-208-18	XPS-1-208-18*3	3	7	(4)
1.33	28	(712)	9	(1.4)	XPS-1.33-1-28	XPS-1.33-208-28		2	7	(4)
1.5	20	(508)	10	(1.6)	XPS-1.5-1-20		XPS-1.5-208-20*3	3	7	(4)
2	28	(712)	9	(1.4)	XPS-2-1-28		XPS-2-208-28*3	3	8	(4)
2.5	30	(762)	11	(1.7)	XPS-2.5-1-30		XPS-2.5-208-30*3	3	9	(5)
3	38	(966)	10	(1.6)	XPS-3-1-38		XPS-3-208-38*3	3	11	(5)
4	54	(1372)	9	(1.4)	XPS-4-1-54		XPS-4-208-54*3	3	11	(5)

**240 & 480 Volt, Single & Three Phase**

kW	Immersion		Watt Density		240V	240V	480V	480V	No. Ele	Est Weight	
	in	(mm)	W/in <sup>2</sup>	(W/cm <sup>2</sup> )	1 Phase	3 Phase	1 Phase	3 Phase		lb	(kg)
0.5	12	(305)	9	(1.4)	XPS-.5-2-12		XPS-.5-4-12		2	5	(3)
0.5	12	(305)	6	(0.9)		XPS-.5-2-12*3		XPS-.5-4-12*3	3	6	(3)
1	18	(458)	8	(1.2)	XPS-1-2-18	XPS-1-2-18*3	XPS-1-4-18	XPS-1-4-18*3	3	7	(4)
1.33	28	(712)	9	(1.4)	XPS-1.33-2-28		XPS-1.33-4-28		2	7	(4)
1.5	20	(508)	10	(1.6)	XPS-1.5-2-20	XPS-1.5-2-20*3	XPS-1.5-4-20	XPS-1.5-4-20*3	3	7	(4)
2	28	(712)	9	(1.4)	XPS-2-2-28	XPS-2-2-28*3	XPS-2-4-28	XPS-2-4-28*3	3	8	(4)
2.5	30	(762)	11	(1.7)	XPS-2.5-2-30	XPS-2.5-2-30*3	XPS-2.5-4-30	XPS-2.5-4-30*3	3	9	(5)
3	38	(966)	10	(1.6)	XPS-3-2-38	XPS-3-2-38*3	XPS-3-4-38	XPS-3-4-38*3	3	11	(5)
4	51	(1296)	9	(1.4)	XPS-4-2-51	XPS-4-2-51*3	XPS-4-4-51	XPS-4-4-51*3	3	11	(5)
5	63	(1601)	10	(1.6)	XPS-5-2-63	XPS-5-2-63*3	XPS-5-4-63	XPS-5-4-63*3	3	11	(5)

For models or options not listed, please refer to our "Quick Quote" on the back inside cover or consult factory.

To place your order or for technical support, please call TOLL FREE 877-399-HEAT (4328) or FAX 401-245-9331



**Screw Plug Heaters - Steel Sheathed Elements**

**2 1/2" NPT  
STEEL Plug**

**0.5 to 5 kW  
6-11 W/in<sup>2</sup>**

**Low Watt Density 6-11 WSI  
120 Volt, Single Phase  
& 208 Volt, Single & Three Phase**

**Steel Sheathed Elements - 6-11 WSI**

kW	Immersion		Watt Density		120V	208V	208V	No. Ele	Est Weight	
	in	(mm)	W/in <sup>2</sup>	(W/cm <sup>2</sup> )	1 Phase	1 Phase	3 Phase		lb	(kg)
0.5	12	(305)	6	(0.9)	XRS-.5-1-12		XRS-.5-208-12*3	3	7	(4)
0.75	12	(305)	9	(1.4)	XRS-.75-1-12	XRS-.75-208-12	XRS-.75-208-12*3	3	7	(4)
1	18	(458)	8	(1.2)	XRS-1-1-18		XRS-1-208-18*3	3	8	(4)
1.5	20	(508)	10	(1.6)	XRS-1.5-1-20		XRS-1.5-208-20*3	3	8	(4)
2	28	(712)	9	(1.4)	XRS-2-1-28		XRS-2-208-28*3	3	9	(5)
2.5	30	(762)	11	(1.7)	XRS-2.5-1-30		XRS-2.5-208-30*3	3	10	(5)
3	38	(966)	10	(1.6)	XRS-3-1-38		XRS-3-208-38*3	3	11	(5)
4	54	(1372)	9	(1.4)	XRS-4-1-54		XRS-4-208-54*3	3	13	(6)

**240 & 480 Volt, Single & Three Phase**

kW	Immersion		Watt Density		240V	240V	480V	480V	No. Ele	Est Weight	
	in	(mm)	W/in <sup>2</sup>	(W/cm <sup>2</sup> )	1 Phase	3 Phase	1 Phase	3 Phase		lb	(kg)
0.5	12	(305)	6	(0.9)	XRS-.5-2-12	XRS-.5-2-12*3	XRS-.5-4-12	XRS-.5-4-12*3	3	7	(4)
0.75	12	(305)	9	(1.4)	XRS-.75-2-12	XRS-.75-2-12*3	XRS-.75-4-12	XRS-.75-4-12*3	3	7	(4)
1	18	(458)	8	(1.2)	XRS-1-2-18	XRS-1-2-18*3	XRS-1-4-18	XRS-1-4-18*3	3	8	(4)
1.5	20	(508)	10	(1.6)	XRS-1.5-2-20	XRS-1.5-2-20*3	XRS-1.5-4-20	XRS-1.5-4-20*3	3	8	(4)
2	28	(712)	9	(1.4)	XRS-2-2-28	XRS-2-2-28*3	XRS-2-4-28	XRS-2-4-28*3	3	9	(5)
2.5	30	(762)	11	(1.7)	XRS-2.5-2-30	XRS-2.5-2-30*3	XRS-2.5-4-30	XRS-2.5-4-30*3	3	10	(5)
3	38	(966)	10	(1.6)	XRS-3-2-38	XRS-3-2-38*3	XRS-3-4-38	XRS-3-4-38*3	3	11	(5)
4	51	(1296)	9	(1.4)	XRS-4-2-51	XRS-4-2-51*3	XRS-4-4-51	XRS-4-4-51*3	3	13	(6)
5	63	(1601)	10	(1.6)	XRS-5-2-63	XRS-5-2-63*3	XRS-5-4-63	XRS-5-4-63*3	3	15	(7)

**3" NPT  
STEEL Plug**

**1.5 to 12 kW  
8-11 W/in<sup>2</sup>**

**120 Volt, Single Phase  
& 208 Volt, Single & Three Phase**

kW	Immersion		Watt Density		120V	208V	208V	No. Ele	Est Weight	
	in	(mm)	W/in <sup>2</sup>	(W/cm <sup>2</sup> )	1 Phase	1 Phase	3 Phase		lb	(kg)
1.5	11.5	(293)	9	(1.4)	XCS-1.5-1-11.5	XCS-1.5-208-11.5	XCS-1.5-208-11.5*3	6	11	(5)
2	17	(432)	8	(1.2)	XCS-2-1-17	XCS-2-208-17	XCS-2-208-17*3	6	12	(6)
3	20	(508)	10	(1.6)	XCS-3-1-20		XCS-3-208-20*3	6	13	(6)
4	28	(712)	9	(1.4)	XCS-4-1-28		XCS-4-208-28*3	6	16	(8)
5	30	(762)	11	(1.7)	XCS-5-1-30		XCS-5-208-30*3	6	16	(8)
6	38	(966)	10	(1.6)	XCS-6-1-38+2		XCS-6-208-38*3	6	19	(9)
8	54	(1372)	9	(1.4)	XCS-8-1-54+2		XCS-8-208-54*3	6	23	(11)
10	66	(1677)	9	(1.4)	XCS-10-1-66+2		XCS-10-208-66*3	6	27	(13)
12	78	(1982)	10	(1.6)			XCS-12-208-78*3	6	31	(15)

**240 & 480 Volt, Single & Three Phase**

kW	Immersion		Watt Density		240V	240V	480V	480V	No. Ele	Est Weight	
	in	(mm)	W/in <sup>2</sup>	(W/cm <sup>2</sup> )	1 Phase	3 Phase	1 Phase	3 Phase		lb	(kg)
1.5	11.5	(293)	9	(1.4)	XCS-1.5-2-11.5	XCS-1.5-2-11.5*3	XCS-1.5-4-11.5		6	11	(5)
2	17	(432)	8	(1.2)	XCS-2-2-17	XCS-2-2-17*3	XCS-2-4-17	XCS-2-4-17*3	6	12	(6)
3	20	(508)	10	(1.6)	XCS-3-2-20	XCS-3-2-20*3	XCS-3-4-20	XCS-3-4-20*3	6	13	(6)
4	28	(712)	9	(1.4)	XCS-4-2-28	XCS-4-2-28*3	XCS-4-4-28	XCS-4-4-28*3	6	16	(8)
5	30	(762)	11	(1.7)	XCS-5-2-30	XCS-5-2-30*3	XCS-5-4-30	XCS-5-4-30*3	6	16	(8)
6	38	(966)	10	(1.6)	XCS-6-2-38	XCS-6-2-38*3	XCS-6-4-38	XCS-6-4-38*3	6	19	(9)
8	54	(1372)	9	(1.4)	XCS-8-2-54	XCS-8-2-54*3	XCS-8-4-54	XCS-8-4-54*3	6	23	(11)
10	66	(1677)	9	(1.4)	XCS-10-2-66	XCS-10-2-66*3	XCS-10-4-66	XCS-10-4-66*3	6	27	(13)
12	78	(1982)	10	(1.6)	XCS-12-2-78+2	XCS-12-2-78*3	XCS-12-4-78	XCS-12-4-78*3	6	31	(15)



**Screw Plug Heaters - Steel Sheathed Elements**

**Typical Applications for  
Steel Sheathed Elements  
16-17 WSI**

- Hydraulic Fluid Applications
- Medium Weight Oils
- Liquid Paraffin
- #4 and #5 Fuel Oils
- Heat Transfer Fluids

The models listed on these pages do not have thermostats, but are available with thermostats. A thermowell is standard in the design of the heaters listed in this catalog to allow for a thermostat/temperature sensing device.

To add a thermostat with a 0° - 100° F range, replace: **X** in model number with **1-**. A heater ordered with a thermostat will be supplied with a high profile terminal enclosure.

**2" NPT  
STEEL Plug**

**1.5 to 9 kW  
16-17 W/in<sup>2</sup>**

**Watt Density 16-17 WSI**

**120 Volt, Single Phase**

**& 208 Volt, Single & Three Phase**

kW	Immersion		Watt Density		120V	208V	208V	No. Ele	Est Weight	
	in	(mm)	W/in <sup>2</sup>	(W/cm <sup>2</sup> )	1 Phase	1 Phase	3 Phase		lb	(kg)
1.5	13	(331)	16	(2.5)	XPS-1.5-1-13	XPS-1.5-208-13	XPS-1.5-208-13*3	3	6	(3)
2	25	(635)	16	(2.5)	XPS-2-1-25	XPS-2-208-25		2	7	(4)
2.66	32	(813)	16	(2.5)	XPS-2.66-1-32	XPS-2.66-208-32		2	7	(4)
3	25	(635)	16	(2.5)	XPS-3-1-25	XPS-3-208-25	XPS-3-208-25*3	3	8	(4)
3.33	40	(1016)	16	(2.5)	XPS-3.33-1-40	XPS-3.33-208-40		2	8	(4)
4	48	(1220)	16	(2.5)		XPS-4-208-48		2	9	(5)
4	32	(813)	16	(2.5)		XPS-4-208-32	XPS-4-208-32*3	3	9	(5)
5	57	(1448)	17	(2.6)		XPS-5-208-57		2	10	(5)
5	40	(1016)	16	(2.5)		XPS-5-208-40	XPS-5-208-40*3	3	10	(5)
6	68	(1728)	17	(2.6)		XPS-6-208-68		2	11	(5)
6	48	(1220)	16	(2.5)		XPS-6-208-48	XPS-6-208-48*3	3	11	(5)
7.5	57	(1448)	17	(2.6)		XPS-7.5-208-57	XPS-7.5-208-57*3	3	13	(6)
9	68	(1728)	17	(2.6)		XPS-9-208-68	XPS-9-208-68*3	3	14	(7)

**240 & 480 Volt, Single & Three Phase**

kW	Immersion		Watt Density		240V	240V	480V	480V	No. Ele	Est Weight	
	in	(mm)	W/in <sup>2</sup>	(W/cm <sup>2</sup> )	1 Phase	3 Phase	1 Phase	3 Phase		lb	(kg)
1.5	13	(331)	16	(2.5)	XPS-1.5-2-13	XPS-1.5-2-13*3	XPS-1.5-4-13	XPS-1.5-4-13*3	3	6	(3)
2	25	(635)	16	(2.5)	XPS-2-2-25		XPS-2-4-25		2	7	(4)
2.66	32	(813)	16	(2.5)	XPS-2.66-2-32		XPS-2.66-4-32		2	7	(4)
3	25	(635)	16	(2.5)	XPS-3-2-25	XPS-3-2-25*3	XPS-3-4-25	XPS-3-4-25*3	3	8	(4)
3.33	40	(1016)	16	(2.5)	XPS-3.33-2-40		XPS-3.33-4-40		2	8	(4)
4	48	(1220)	16	(2.5)	XPS-4-2-48		XPS-4-4-48		2	9	(5)
4	32	(813)	16	(2.5)	XPS-4-2-32	XPS-4-2-32*3	XPS-4-4-32	XPS-4-4-32*3	3	9	(5)
5	57	(1448)	17	(2.6)	XPS-5-2-57		XPS-5-4-57		2	10	(5)
5	40	(1016)	16	(2.5)	XPS-5-2-40	XPS-5-2-40*3	XPS-5-4-40	XPS-5-4-40*3	3	10	(5)
6	68	(1728)	17	(2.6)	XPS-6-2-68		XPS-6-4-68		2	11	(5)
6	48	(1220)	16	(2.5)	XPS-6-2-48	XPS-6-2-48*3	XPS-6-4-48	XPS-6-4-48*3	3	11	(5)
7.5	57	(1448)	17	(2.6)	XPS-7.5-2-57	XPS-7.5-2-57*3	XPS-7.5-4-57	XPS-7.5-4-57*3	3	13	(6)
9	68	(1728)	17	(2.6)	XPS-9-2-68	XPS-9-2-68*3	XPS-9-4-68	XPS-9-4-68*3	3	14	(7)

For models or options not listed, please refer to our "Quick Quote" on the back inside cover or consult factory.

To place your order or for technical support, please call TOLL FREE 877-399-HEAT (4328) or FAX 401-245-9331

or check our web site: [www.warrenonline.com](http://www.warrenonline.com)



**Screw Plug Heaters - Steel Sheathed Elements**

**2 1/2" NPT  
STEEL Plug**

1.5 to 9 kW  
16-17 W/in<sup>2</sup>

**Watt Density 16-17 WSI**  
120 Volt, Single Phase  
& 208 Volt, Single & Three Phase

**Steel Sheathed Elements - 16-17 WSI**

kW	Immersion		Watt Density		120V	208V	208V	No. Ele	Est Weight	
	in	(mm)	W/in <sup>2</sup>	(W/cm <sup>2</sup> )	1 Phase	1 Phase	3 Phase		lb	(kg)
1.5	13	(331)	16	(2.5)	XRS-1.5-1-13	XRS-1.5-208-13	XRS-1.5-208-13*3	3	7	(4)
2	17	(432)	16	(2.5)	XRS-2-1-17	XRS-2-208-17	XRS-2-208-17*3	3	8	(4)
2.5	20	(508)	17	(2.6)	XRS-2.5-1-20	XRS-2.5-208-20	XRS-2.5-208-20*3	3	8	(4)
3	25	(635)	16	(2.5)	XRS-3-1-25	XRS-3-208-25	XRS-3-208-25*3	3	9	(5)
4	32	(813)	16	(2.5)		XRS-4-208-32	XRS-4-208-32*3	3	10	(5)
5	40	(1016)	16	(2.5)		XRS-5-208-40	XRS-5-208-40*3	3	11	(5)
6	48	(1220)	16	(2.5)		XRS-6-208-48	XRS-6-208-48*3	3	12	(6)

**240 & 480 Volt, Single & Three Phase**

kW	Immersion		Watt Density		240V	240V	480V	480V	No. Ele	Est Weight	
	in	(mm)	W/in <sup>2</sup>	(W/cm <sup>2</sup> )	1 Phase	3 Phase	1 Phase	3 Phase		lb	(kg)
1.5	13	(331)	16	(2.5)	XRS-1.5-2-13	XRS-1.5-2-13*3	XRS-1.5-4-13	XRS-1.5-4-13*3	3	5	(3)
2	17	(432)	16	(2.5)	XRS-2-2-17	XRS-2-2-17*3	XRS-2-4-17	XRS-2-4-17*3	3	5	(3)
2.5	20	(508)	17	(2.6)	XRS-2.5-2-20	XRS-2.5-2-20*3	XRS-2.5-4-20	XRS-2.5-4-20*3	3	5	(3)
3	25	(635)	16	(2.5)	XRS-3-2-25	XRS-3-2-25*3	XRS-3-4-25	XRS-3-4-25*3	3	6	(3)
4	32	(813)	16	(2.5)	XRS-4-2-32	XRS-4-2-32*3	XRS-4-4-32	XRS-4-4-32*3	3	6	(3)
5	40	(1016)	16	(2.5)	XRS-5-2-40	XRS-5-2-40*3	XRS-5-4-40	XRS-5-4-40*3	3	6	(3)
6	48	(1220)	16	(2.5)	XRS-6-2-48	XRS-6-2-48*3	XRS-6-4-48	XRS-6-4-48*3	3	6	(3)
7.5	57	(1448)	17	(2.6)	XRS-7.5-2-57	XRS-7.5-2-57*3	XRS-7.5-4-57	XRS-7.5-4-57*3	3	7	(4)
9	68	(1728)	17	(2.6)	XRS-9-2-68	XRS-9-2-68*3	XRS-9-4-68	XRS-9-4-68*3	3	7	(4)

**3" NPT  
STEEL Plug**

3 to 18 kW  
16-17 W/in<sup>2</sup>

**Watt Density 16-17 WSI**  
120 Volt, Single Phase  
& 208 Volt, Single & Three Phase

kW	Immersion		Watt Density		120V	208V	208V	No. Ele	Est Weight	
	in	(mm)	W/in <sup>2</sup>	(W/cm <sup>2</sup> )	1 Phase	1 Phase	3 Phase		lb	(kg)
3	13	(331)	16	(2.5)	XCS-3-1-13	XCS-3-208-13	XCS-3-208-13*3	6	11	(5)
4	17	(432)	16	(2.5)	XCS-4-1-17	XCS-4-208-17	XCS-4-208-17*3	6	12	(6)
5	20	(508)	17	(2.6)	XCS-5-1-20	XCS-5-208-20	XCS-5-208-20*3	6	13	(6)
6	25	(635)	16	(2.5)	XCS-6-1-25+2	XCS-6-208-25	XCS-6-208-25*3	6	15	(7)
8	32	(813)	16	(2.5)		XCS-8-208-32	XCS-8-208-32*3	6	17	(8)
10	40	(1016)	16	(2.5)		XCS-10-208-40	XCS-10-208-40*3	6	19	(9)
12	48	(1220)	16	(2.5)		XCS-12-208-48+2	XCS-12-208-48*3	6	21	(10)

**240 & 480 Volt, Single & Three Phase**

kW	Immersion		Watt Density		240V	240V	480V	480V	No. Ele	Est Weight	
	in	(mm)	W/in <sup>2</sup>	(W/cm <sup>2</sup> )	1 Phase	3 Phase	1 Phase	3 Phase		lb	(kg)
3	13	(331)	16	(2.5)	XCS-3-2-13	XCS-3-2-13*3	XCS-3-4-13	XCS-3-4-13*3	6	11	(5)
4	17	(432)	16	(2.5)	XCS-4-2-17	XCS-4-2-17*3	XCS-4-4-17	XCS-4-4-17*3	6	12	(6)
5	20	(508)	17	(2.6)	XCS-5-2-20	XCS-5-2-20*3	XCS-5-4-20	XCS-5-4-20*3	6	13	(6)
6	25	(635)	16	(2.5)	XCS-6-2-25	XCS-6-2-25*3	XCS-6-4-25	XCS-6-4-25*3	6	15	(7)
8	32	(813)	16	(2.5)	XCS-8-2-32	XCS-8-2-32*3	XCS-8-4-32	XCS-8-4-32*3	6	17	(8)
10	40	(1016)	16	(2.5)	XCS-10-2-40	XCS-10-2-40*3	XCS-10-4-40	XCS-10-4-40*3	6	19	(9)
12	48	(1220)	16	(2.5)	XCS-12-2-48+2	XCS-12-2-48*3	XCS-12-4-48	XCS-12-4-48*3	6	21	(10)
15	57	(1448)	17	(2.6)	XCS-15-2-57+2	XCS-15-2-57*3	XCS-15-4-57	XCS-15-4-57*3	6	24	(11)
18	68	(1728)	17	(2.6)	XCS-18-2-68+2	XCS-18-2-68*3	XCS-18-4-68	XCS-18-4-68*3	6	28	(13)





## Screw Plug Heaters - Steel Sheathed Elements

### Typical Applications for Steel Sheathed Elements 23-27 WSI

- Degreasing Solutions
- Mineral Oils
- Light Lubrication Oils
- Flowing Hydraulic Fluids
- Flowing Heat Transfer Fluids

The models listed on these pages do not have thermostats, but are available with thermostats. A thermowell is standard in the design of the heaters listed in this catalog to allow for a thermostat/temperature sensing device.

To add a thermostat with a  $0^{\circ} - 100^{\circ} F$  range, replace: **X** in model number with **1-**. A heater ordered with a thermostat will be supplied with a high profile terminal enclosure.

### 1" NPT STEEL Plug

0.25 to 1.5 kW  
23 W/in<sup>2</sup>

### Watt Density 23 WSI

120, 208, & 240 Volt, Single Phase

kW	Immersion		Watt Density		120V	208V	240V	No. Ele	Est Weight	
	in	(mm)	W/in <sup>2</sup>	(W/cm <sup>2</sup> )	1 Phase	1 Phase	1 Phase		lb	(kg)
0.25	6.5	(166)	23	(3.6)	XFS-.25-1-6.5			1	3	(2)
0.375	9.5	(242)	23	(3.6)	XFS-.375-1-9.5	XFS-.375-208-9.5	XFS-.375-2-9.5	1	3	(2)
0.5	12	(305)	23	(3.6)	XFS-.5-1-12	XFS-.5-208-12	XFS-.5-2-12	1	3	(2)
0.75	18	(458)	23	(3.6)	XFS-.75-1-18	XFS-.75-208-18	XFS-.75-2-18	1	4	(2)
1	23	(585)	23	(3.6)	XFS-1-1-23	XFS-1-208-23	XFS-1-2-23	1	4	(2)
1.5	34	(864)	23	(3.6)	XFS-1.5-1-34	XFS-1.5-208-34	XFS-1.5-2-34	1	4	(2)

### 1 1/4" NPT STEEL Plug

0.5 to 3 kW  
23 W/in<sup>2</sup>

### Watt Density 23 WSI

120, 208, & 240 Volt, Single Phase

kW	Immersion		Watt Density		120V	208V	240V	No. Ele	Est Weight	
	in	(mm)	W/in <sup>2</sup>	(W/cm <sup>2</sup> )	1 Phase	1 Phase	1 Phase		lb	(kg)
0.5	6.5	(166)	23	(3.6)	XGS-.5-1-6.5	XGS-.5-208-6.5	XGS-.5-2-6.5	2	4	(2)
0.75	9.5	(242)	23	(3.6)	XGS-.75-1-9.5	XGS-.75-208-9.5	XGS-.75-2-9.5	2	4	(2)
1	12	(305)	23	(3.6)	XGS-1-1-12	XGS-1-208-12	XGS-1-2-12	2	4	(2)
1.5	18	(458)	23	(3.6)	XGS-1.5-1-18	XGS-1.5-208-18	XGS-1.5-2-18	2	5	(3)
2	23	(585)	23	(3.6)	XGS-2-1-23	XGS-2-208-23	XGS-2-2-23	2	6	(3)
3	34	(864)	23	(3.6)	XGS-3-1-34	XGS-3-208-34	XGS-3-2-34	2	7	(4)

For models or options not listed, please refer to our "Quick Quote" on the back inside cover or consult factory.

To place your order or for technical support, please call TOLL FREE 877-399-HEAT (4328) or FAX 401-245-9331



**Screw Plug Heaters - Steel Sheathed Elements**

**2" NPT  
STEEL Plug**

1.5 to 12.5 kW  
24-27 W/in<sup>2</sup>

**Watt Density 24-27 WSI**  
120 Volt, Single Phase  
& 208 Volt, Single & Three Phase

kW	Immersion		Watt Density		120V	208V	208V	No. Ele	Est Weight	
	in	(mm)	W/in <sup>2</sup>	(W/cm <sup>2</sup> )	1 Phase	1 Phase	3 Phase		lb	(kg)
1.5	12	(305)	27	(4.2)	XPS-1.5-1-12	XPS-1.5-208-12		2	5	(3)
2	18	(458)	24	(3.7)	XPS-2-1-18	XPS-2-208-18		2	6	(3)
2.5	20	(508)	25	(3.9)	XPS-2.5-1-20	XPS-2.5-208-20		2	6	(3)
3	25	(635)	24	(3.7)	XPS-3-1-25	XPS-3-208-25		2	7	(4)
3	18	(458)	24	(3.7)	XPS-3-1-18	XPS-3-208-18	XPS-3-208-18*3	3	7	(4)
4	32.5	(826)	24	(3.7)	XPS-4-1-32.5	XPS-4-208-32.5		2	7	(4)
4.5	25	(635)	24	(3.7)	XPS-4.5-1-25	XPS-4.5-208-25	XPS-4.5-208-25*3	3	8	(4)
6	47.5	(1207)	24	(3.7)		XPS-6-208-47.5		2	9	(5)
6	32.5	(826)	24	(3.7)		XPS-6-208-32.5	XPS-6-208-32.5*3	3	9	(5)
7.5	40	(1016)	24	(3.7)		XPS-7.5-208-40	XPS-7.5-208-40*3	3	10	(5)
9	47.5	(1207)	24	(3.7)		XPS-9-208-47.5	XPS-9-208-47.5*3	3	11	(5)
12.5	64	(1626)	24	(3.7)			XPS-12.5-208-64*3	3	14	(7)

**2" NPT  
STEEL Plug**

1.5 to 12.5 kW  
24-27 W/in<sup>2</sup>

**Watt Density 24-27 WSI**  
240 & 480 Volt, Single & Three Phase

kW	Immersion		Watt Density		240V	240V	480V	480V	No. Ele	Est Weight	
	in	(mm)	W/in <sup>2</sup>	(W/cm <sup>2</sup> )	1 Phase	3 Phase	1 Phase	3 Phase		lb	(kg)
1.5	12	(305)	27	(4.2)	XPS-1.5-2-12		XPS-1.5-4-12		2	5	(3)
2	18	(458)	24	(3.7)	XPS-2-2-18		XPS-2-4-18		2	6	(3)
2.5	20	(508)	25	(3.9)	XPS-2.5-2-20		XPS-2.5-4-20		2	6	(3)
3	25	(635)	24	(3.7)	XPS-3-2-25		XPS-3-4-25		2	7	(4)
3	18	(458)	24	(3.7)	XPS-3-2-18	XPS-3-2-18*3	XPS-3-4-18	XPS-3-4-18*3	3	7	(4)
4	32.5	(826)	24	(3.7)	XPS-4-2-32.5		XPS-4-4-32.5		2	7	(4)
4.5	25	(635)	24	(3.7)	XPS-4.5-2-25	XPS-4.5-2-25*3	XPS-4.5-4-25	XPS-4.5-4-25*3	3	8	(4)
5	40	(1016)	24	(3.7)	XPS-5-2-40		XPS-5-4-40		2	8	(4)
6	47.5	(1207)	24	(3.7)	XPS-6-2-47.5		XPS-6-4-47.5		2	9	(5)
6	32.5	(826)	24	(3.7)	XPS-6-2-32.5	XPS-6-2-32.5*3	XPS-6-4-32.5	XPS-6-4-32.5*3	3	9	(5)
7.5	40	(1016)	24	(3.7)	XPS-7.5-2-40	XPS-7.5-2-40*3	XPS-7.5-4-40	XPS-7.5-4-40*3	3	10	(5)
9	47.5	(1207)	24	(3.7)	XPS-9-2-47.5	XPS-9-2-47.5*3	XPS-9-4-47.5	XPS-9-4-47.5*3	3	11	(5)
12.5	64	(1626)	24	(3.7)	XPS-12.5-2-64	XPS-12.5-2-64*3	XPS-12.5-4-64	XPS-12.5-4-64*3	3	14	(7)

**Steel Sheathed Elements - 23-27 WSI**

For models or options not listed, please refer to our "Quick Quote" on the back inside cover or consult factory.

To place your order or for technical support, please call TOLL FREE 877-399-HEAT (4328) or FAX 401-245-9331

or check our web site: [www.warrenonline.com](http://www.warrenonline.com)



**Screw Plug Heaters - Steel Sheathed Elements**

**2 1/2" NPT  
STEEL Plug**

**3 to 15 kW  
24-25 W/in<sup>2</sup>**

**Watt Density 24-25 WSI  
120 Volt, Single Phase  
& 208 Volt, Single & Three Phase**

kW	Immersion		Watt Density		120V	208V	208V	No. Ele	Est Weight	
	in	(mm)	W/in <sup>2</sup>	(W/cm <sup>2</sup> )	1 Phase	1 Phase	3 Phase		lb	(kg)
3	18	(458)	24	(3.7)	XRS-3-1-18	XRS-3-208-18	XRS-3-208-18*3	3	8	(4)
4.5	25	(635)	24	(3.7)	XRS-4.5-1-25	XRS-4.5-208-25	XRS-4.5-208-25*3	3	9	(5)
6	32.5	(826)	24	(3.7)		XRS-6-208-32.5	XRS-6-208-32.5*3	3	10	(5)
7.5	40	(1016)	24	(3.7)		XRS-7.5-208-40	XRS-7.5-208-40*3	3	11	(5)
9	47.5	(1207)	24	(3.7)		XRS-9-208-47.5	XRS-9-208-47.5*3	3	12	(6)
12.5	64	(1626)	24	(3.7)			XRS-12.5-208-64*3	3	15	(7)

**240 & 480 Volt, Single & Three Phase**

kW	Immersion		Watt Density		240V	240V	480V	480V	No. Ele	Est Weight	
	in	(mm)	W/in <sup>2</sup>	(W/cm <sup>2</sup> )	1 Phase	3 Phase	1 Phase	3 Phase		lb	(kg)
3	18	(458)	24	(3.7)	XRS-3-2-18	XRS-3-2-18*3	XRS-3-4-18	XRS-3-4-18*3	3	8	(4)
4.5	25	(635)	24	(3.7)	XRS-4.5-2-25	XRS-4.5-2-25*3	XRS-4.5-4-25	XRS-4.5-4-25*3	3	9	(5)
6	32.5	(826)	24	(3.7)	XRS-6-2-32.5	XRS-6-2-32.5*3	XRS-6-4-32.5	XRS-6-4-32.5*3	3	10	(5)
7.5	40	(1016)	24	(3.7)	XRS-7.5-2-40	XRS-7.5-2-40*3	XRS-7.5-4-40	XRS-7.5-4-40*3	3	11	(5)
9	47.5	(1207)	24	(3.7)	XRS-9-2-47.5	XRS-9-2-47.5*3	XRS-9-4-47.5	XRS-9-4-47.5*3	3	12	(6)
12.5	64	(1626)	24	(3.7)		XRS-12.5-2-64*3	XRS-12.5-4-64	XRS-12.5-4-64*3	3	15	(7)
15	76	(1931)	25	(3.9)		XRS-15-2-76*3	XRS-15-4-76	XRS-15-4-76*3	3	17	(8)

**3" NPT  
STEEL Plug**

**6 to 30 kW  
24-25 W/in<sup>2</sup>**

**Watt Density 24-25 WSI  
208 Volt, Single & Three Phase**

kW	Immersion		Watt Density		208V	208V	No. Ele	Est Weight	
	in	(mm)	W/in <sup>2</sup>	(W/cm <sup>2</sup> )	1 Phase	3 Phase		lb	(kg)
6	18	(458)	24	(3.7)	XCS-6-208-18	XCS-6-208-18*3	6	12	(6)
9	25	(635)	24	(3.7)	XCS-9-208-25	XCS-9-208-25*3	6	14	(7)
12	32.5	(826)	24	(3.7)		XCS-12-208-32.5*3	6	17	(8)
15	40	(1016)	24	(3.7)		XCS-15-208-40*3	6	19	(9)

**240 & 480 Volt, Single & Three Phase**

kW	Immersion		Watt Density		240V	240V	480V	480V	No. Ele	Est Weight	
	in	(mm)	W/in <sup>2</sup>	(W/cm <sup>2</sup> )	1 Phase	3 Phase	1 Phase	3 Phase		lb	(kg)
6	18	(458)	24	(3.7)	XCS-6-2-18	XCS-6-2-18*3	XCS-6-4-18	XCS-6-4-18*3	6	12	(6)
9	25	(635)	24	(3.7)	XCS-9-2-25	XCS-9-2-25*3	XCS-9-4-25	XCS-9-4-25*3	6	14	(7)
12	32.5	(826)	24	(3.7)	XCS-12-2-32.5+2	XCS-12-2-32.5*3	XCS-12-4-32.5	XCS-12-4-32.5*3	6	17	(8)
15	40	(1016)	24	(3.7)	XCS-15-2-40+2	XCS-15-2-40*3	XCS-15-4-40	XCS-15-4-40*3	6	19	(9)
18	47.5	(1207)	24	(3.7)	XCS-18-2-47.5+2	XCS-18-2-47.5*3	XCS-18-4-47.5	XCS-18-4-47.5*3	6	21	(10)
25	64	(1626)	24	(3.7)		XCS-25-2-64*3+2	XCS-25-4-64+2	XCS-25-4-64*3	6	26	(12)
30	76	(1931)	25	(3.9)		XCS-30-2-76*3+2	XCS-30-4-76+2	XCS-30-4-76*3	6	30	(14)

For models or options not listed, please refer to our "Quick Quote" on the back inside cover or consult factory.

To place your order or for technical support, please call TOLL FREE 877-399-HEAT (4328) or FAX 401-245-9331



**Screw Plug Heaters - Incoloy Sheathed Elements**

**Typical Applications for  
Incoloy Sheathed Elements  
16-17 WSI**

- Citric-Based Fluids
- Flowing Steam
- and many Highlky Corrosive Chemical Solutions

The models listed on these pages do not have thermostats, but are available with thermostats. A thermowell is standard in the design of the heaters listed in this catalog to allow for a thermostat/temperature sensing device.

To add a thermostat with a 60° - 250° F range, replace: X in model number with 2-. A heater ordered with a thermostat will be supplied with a high profile terminal enclosure.

**2" NPT  
S.S. Plug**

**2 to 9 kW  
16-17 W/in<sup>2</sup>**

**Watt Density 16-17 WSI  
120 Volt, Single Phase  
& 208 Volt, Single & Three Phase**

kW	Immersion		Watt Density		120V	208V	208V	No. Ele	Est Weight	
	in	(mm)	W/in <sup>2</sup>	(W/cm <sup>2</sup> )	1 Phase	1 Phase	3 Phase		lb	(kg)
2	25	(635)	16	(2.5)	XPS-2-1-25IC	XPS-2-208-25IC		2	7	(4)
3	25	(635)	16	(2.5)	XPS-3-1-25IC	XPS-3-208-25IC	XPS-3-208-25IC*3	3	8	(4)
3.33	40	(1016)	16	(2.5)	XPS-3.33-1-40IC	XPS-3.33-208-40IC		2	8	(4)
4	48	(1220)	16	(2.5)	XPS-4-1-48IC	XPS-4-208-48IC		2	9	(5)
5	56	(1423)	17	(2.6)	XPS-5-1-56IC	XPS-5-208-56IC		2	10	(5)
5	40	(1016)	16	(2.5)	XPS-5-1-40IC	XPS-5-208-40IC	XPS-5-208-40IC*3	3	10	(5)
6	67	(1702)	17	(2.6)		XPS-6-208-67IC		2	11	(5)
6	48	(1220)	16	(2.5)		XPS-6-208-48IC	XPS-6-208-48IC*3	3	11	(5)
7.5	56	(1423)	17	(2.6)		XPS-7.5-208-56IC	XPS-7.5-208-56IC*3	3	13	(6)
9	67	(1702)	17	(2.6)		XPS-9-208-67IC	XPS-9-208-67IC*3	3	14	(7)

**240 & 480 Volt, Single & Three Phase**

kW	Immersion		Watt Density		240V	240V	480V	480V	No. Ele	Est Weight	
	in	(mm)	W/in <sup>2</sup>	(W/cm <sup>2</sup> )	1 Phase	3 Phase	1 Phase	3 Phase		lb	(kg)
2	25	(635)	16	(2.5)	XPS-2-2-25IC		XPS-2-4-25IC		2	7	(4)
3	25	(635)	16	(2.5)	XPS-3-2-25IC	XPS-3-2-25IC*3	XPS-3-4-25IC	XPS-3-4-25IC*3	3	8	(4)
3.33	40	(1016)	16	(2.5)	XPS-3.33-2-40IC		XPS-3.33-4-40IC		2	8	(4)
4	48	(1220)	16	(2.5)	XPS-4-2-48IC		XPS-4-4-48IC		2	9	(5)
5	56	(1423)	17	(2.6)	XPS-5-2-56IC		XPS-5-4-56IC		2	10	(5)
5	40	(1016)	16	(2.5)	XPS-5-2-40IC	XPS-5-2-40IC*3	XPS-5-4-40IC	XPS-5-4-40IC*3	3	10	(5)
6	67	(1702)	17	(2.6)	XPS-6-2-67IC		XPS-6-4-67IC		2	11	(5)
6	48	(1220)	16	(2.5)	XPS-6-2-48IC	XPS-6-2-48IC*3	XPS-6-4-48IC	XPS-6-4-48IC*3	3	11	(5)
7.5	56	(1423)	17	(2.6)	XPS-7.5-2-56IC	XPS-7.5-2-56IC*3	XPS-7.5-4-56IC	XPS-7.5-4-56IC*3	3	13	(6)
9	67	(1702)	17	(2.6)	XPS-9-2-67IC	XPS-9-2-67IC*3	XPS-9-4-67IC	XPS-9-4-67IC*3	3	14	(7)

**Incoloy Sheathed Elements - 16-17 WSI**

For models or options not listed, please refer to our "Quick Quote" on the back inside cover or consult factory.

To place your order or for technical support, please call TOLL FREE 877-399-HEAT (4328) or FAX 401-245-9331

or check our web site: [www.warrenonline.com](http://www.warrenonline.com)



**Screw Plug Heaters - Incoloy Sheathed Elements**

**2 1/2" NPT  
S.S. Plug**

**3 to 9 kW  
16-17 W/in<sup>2</sup>**

**Watt Density 16-17 WSI  
120 Volt, Single Phase  
& 208 Volt, Single & Three Phase**

kW	Immersion		Watt Density		120V	208V	208V	No. Ele	Est Weight	
	in	(mm)	W/in <sup>2</sup>	(W/cm <sup>2</sup> )	1 Phase	1 Phase	3 Phase		lb	(kg)
3	25	(635)	16	(2.5)	XRS-3-1-25IC	XRS-3-208-25IC	XRS-3-208-25IC*3	3	9	(5)
4	32	(813)	16	(2.5)	XRS-4-1-32IC	XRS-4-208-32IC	XRS-4-208-32IC*3	3	10	(5)
5	40	(1016)	16	(2.5)		XRS-5-208-40IC	XRS-5-208-40IC*3	3	11	(5)
6	48	(1220)	16	(2.5)		XRS-6-208-48IC	XRS-6-208-48IC*3	3	12	(6)
7.5	56	(1423)	17	(2.6)		XRS-7.5-208-56IC	XRS-7.5-208-56IC*3	3	14	(7)
9	67	(1702)	17	(2.6)		XRS-9-208-67IC	XRS-9-208-67IC*3	3	16	(8)

**240 & 480 Volt, Single & Three Phase**

kW	Immersion		Watt Density		240V	240V	480V	480V	No. Ele	Est Weight	
	in	(mm)	W/in <sup>2</sup>	(W/cm <sup>2</sup> )	1 Phase	3 Phase	1 Phase	3 Phase		lb	(kg)
3	25	(635)	16	(2.5)	XRS-3-2-25IC	XRS-3-2-25IC*3	XRS-3-4-25IC	XRS-3-4-25IC*3	3	9	(5)
4	32	(813)	16	(2.5)	XRS-4-2-32IC	XRS-4-2-32IC*3	XRS-4-4-32IC	XRS-4-4-32IC*3	3	10	(5)
5	40	(1016)	16	(2.5)	XRS-5-2-40IC	XRS-5-2-40IC*3	XRS-5-4-40IC	XRS-5-4-40IC*3	3	11	(5)
6	48	(1220)	16	(2.5)	XRS-6-2-48IC	XRS-6-2-48IC*3	XRS-6-4-48IC	XRS-6-4-48IC*3	3	12	(6)
7.5	56	(1423)	17	(2.6)	XRS-7.5-2-56IC	XRS-7.5-2-56IC*3	XRS-7.5-4-56IC	XRS-7.5-4-56IC*3	3	14	(7)
9	67	(1702)	17	(2.6)	XRS-9-2-67IC	XRS-9-2-67IC*3	XRS-9-4-67IC	XRS-9-4-67IC*3	3	16	(8)

**3" NPT  
S.S. Plug**

**6 to 18 kW  
16-17 W/in<sup>2</sup>**

**Watt Density 16-17 WSI  
120 Volt, Single Phase  
& 208 Volt, Single & Three Phase**

kW	Immersion		Watt Density		120V	208V	208V	No. Ele	Est Weight	
	in	(mm)	W/in <sup>2</sup>	(W/cm <sup>2</sup> )	1 Phase	1 Phase	3 Phase		lb	(kg)
6	25	(635)	16	(2.5)	XCS-6-1-25IC+2	XCS-6-208-25IC	XCS-6-208-25IC*3	6	15	(7)
8	32	(813)	16	(2.5)	XCS-8-1-32IC+2	XCS-8-208-32IC	XCS-8-208-32IC*3	6	17	(8)
10	40	(1016)	16	(2.5)		XCS-10-208-40IC	XCS-10-208-40IC*3	6	20	(10)
12	48	(1220)	16	(2.5)		XCS-12-208-48IC+2	XCS-12-208-48IC*3	6	22	(10)
15	56	(1423)	17	(2.6)		XCS-15-208-56IC+2	XCS-15-208-56IC*3	6	25	(12)
18	67	(1702)	17	(2.6)		XCS-18-208-67IC+2	XCS-18-208-67IC*3+2	6	28	(13)

**240 & 480 Volt, Single & Three Phase**

kW	Immersion		Watt Density		240V	240V	480V	480V	No. Ele	Est Weight	
	in	(mm)	W/in <sup>2</sup>	(W/cm <sup>2</sup> )	1 Phase	3 Phase	1 Phase	3 Phase		lb	(kg)
6	25	(635)	16	(2.5)	XCS-6-2-25IC	XCS-6-2-25IC*3	XCS-6-4-25IC	XCS-6-4-25IC*3	6	15	(7)
8	32	(813)	16	(2.5)	XCS-8-2-32IC	XCS-8-2-32IC*3	XCS-8-4-32IC	XCS-8-4-32IC*3	6	17	(8)
10	40	(1016)	16	(2.5)	XCS-10-2-40IC	XCS-10-2-40IC*3	XCS-10-4-40IC	XCS-10-4-40IC*3	6	20	(10)
12	48	(1220)	16	(2.5)	XCS-12-2-48IC+2	XCS-12-2-48IC*3	XCS-12-4-48IC	XCS-12-4-48IC*3	6	22	(10)
15	56	(1423)	17	(2.6)	XCS-15-2-56IC+2	XCS-15-2-56IC*3	XCS-15-4-56IC	XCS-15-4-56IC*3	6	25	(12)
18	67	(1702)	17	(2.6)	XCS-18-2-67IC+2	XCS-18-2-67IC*3	XCS-18-4-67IC	XCS-18-4-67IC*3	6	28	(13)

For models or options not listed, please refer to our "Quick Quote" on the back inside cover or consult factory.

To place your order or for technical support, please call TOLL FREE 877-399-HEAT (4328) or FAX 401-245-9331





**Screw Plug Heaters - Incoloy Sheathed Elements**

**Typical Applications for  
Incoloy Sheathed Elements  
22-24 WSI**

- Forced Air & Gases
- Vegetable Oils
- Ethylene Glycol
- Causic Solutions
- and many Mildly Corrosive Chemical Solutions

The models listed on these pages do not have thermostats, but are available with thermostats. A thermowell is standard in the design of the heaters listed in this catalog to allow for a thermostat/temperature sensing device.

To add a thermostat with a 60° - 250° F range, replace: X in model number with 2-. A heater ordered with a thermostat will be supplied with a high profile terminal enclosure.

**Incoloy Sheathed Elements - 22-24 WSI**

**1" NPT  
S.S. Plug**

**0.375 to 1 kW  
22-23 W/in<sup>2</sup>**

**Watt Density 22-23 WSI**

**120 & 240 Volt, Single Phase**

kW	Immersion		Watt Density		120V 1 Phase	240V 1 Phase	No. Ele	Est Weight	
	in	(mm)	W/in <sup>2</sup>	(W/cm <sup>2</sup> )				lb	(kg)
0.375	9.5	(242)	22	(3.4)	XFS-.375-1-9.5IC	XFS-.375-2-9.5IC	1	3	(2)
0.5	12	(305)	23	(3.6)	XFS-.5-1-12IC	XFS-.5-2-12IC	1	3	(2)
0.75	18	(458)	22	(3.4)	XFS-.75-1-18IC	XFS-.75-2-18IC	1	4	(2)
1	23	(585)	23	(3.6)	XFS-1-1-23IC	XFS-1-2-23IC	1	4	(2)

**1 1/4" NPT  
S.S. Plug**

**0.75 to 2 kW  
22-23 W/in<sup>2</sup>**

**120 & 240 Volt, Single Phase**

kW	Immersion		Watt Density		120V 1 Phase	240V 1 Phase	No. Ele	Est Weight	
	in	(mm)	W/in <sup>2</sup>	(W/cm <sup>2</sup> )				lb	(kg)
0.75	9.5	(242)	22	(3.4)	XGS-.75-1-9.5IC	XGS-.75-2-9.5IC	2	4	(2)
1	12	(305)	23	(3.6)	XGS-1-1-12IC	XGS-1-2-12IC	2	4	(2)
1.5	18	(458)	22	(3.4)	XGS-1.5-1-18IC	XGS-1.5-2-18IC	2	5	(3)
2	23	(585)	23	(3.6)	XGS-2-1-23IC	XGS-2-2-23IC	2	5	(3)

For models or options not listed, please refer to our "Quick Quote" on the back inside cover or consult factory.

To place your order or for technical support, please call TOLL FREE 877-399-HEAT (4328) or FAX 401-245-9331



## Screw Plug Heaters - Incoloy Sheathed Elements

**2" NPT  
S.S. Plug**

2 to 15 kW  
23-24 W/in<sup>2</sup>

**Watt Density 23-24 WSI**  
**120 Volt, Single Phase**  
**& 208 Volt, Single & Three Phase**

kW	Immersion		Watt Density		120V	208V	208V	No. Ele	Est Weight	
	in	(mm)	W/in <sup>2</sup>	(W/cm <sup>2</sup> )	1 Phase	1 Phase	3 Phase		lb	(kg)
2	18	(458)	23	(3.6)	XPS-2-1-18IC	XPS-2-208-18IC		2	6	(3)
3	25	(635)	24	(3.7)	XPS-3-1-25IC-Y	XPS-3-208-25IC-Y		2	7	(4)
3	18	(458)	24	(3.7)	XPS-3-1-18IC	XPS-3-208-18IC	XPS-3-208-18IC*3	3	7	(4)
4	33	(839)	24	(3.7)	XPS-4-1-33IC	XPS-4-208-33IC		2	7	(4)
4.5	25	(635)	24	(3.7)	XPS-4.5-1-25IC	XPS-4.5-208-25IC	XPS-4.5-208-25IC*3	3	8	(4)
5	40	(1016)	24	(3.7)	XPS-5-1-40IC	XPS-5-208-40IC		2	8	(4)
6	48	(1220)	24	(3.7)		XPS-6-208-48IC		2	9	(5)
6	33	(839)	24	(3.7)		XPS-6-208-33IC	XPS-6-208-33IC*3	3	9	(5)
7.5	40	(1016)	24	(3.7)		XPS-7.5-208-40IC	XPS-7.5-208-40IC*3	3	10	(5)
9	48	(1220)	24	(3.7)		XPS-9-208-48IC	XPS-9-208-48IC*3	3	11	(5)
12	64	(1626)	24	(3.7)			XPS-12-208-64IC*3	3	14	(7)

### 240 & 480 Volt, Single & Three Phase

kW	Immersion		Watt Density		240V	240V	480V	480V	No. Ele	Est Weight	
	in	(mm)	W/in <sup>2</sup>	(W/cm <sup>2</sup> )	1 Phase	3 Phase	1 Phase	3 Phase		lb	(kg)
2	18	(458)	23	(3.6)	XPS-2-2-18IC		XPS-2-4-18IC		2	6	(3)
3	25	(635)	24	(3.7)	XPS-3-2-25IC		XPS-3-4-25IC		2	7	(4)
3	18	(458)	24	(3.7)	XPS-3-2-18IC	XPS-3-2-18IC*3	XPS-3-4-18IC	XPS-3-4-18IC*3	3	7	(4)
4	33	(839)	24	(3.7)	XPS-4-2-33IC		XPS-4-4-33IC		2	7	(4)
4.5	25	(635)	24	(3.7)	XPS-4.5-2-25IC	XPS-4.5-2-25IC*3	XPS-4.5-4-25IC	XPS-4.5-4-25IC*3	3	8	(4)
5	40	(1016)	24	(3.7)	XPS-5-2-40IC		XPS-5-4-40IC		2	8	(4)
6	48	(1220)	24	(3.7)	XPS-6-2-48IC		XPS-6-4-48IC		2	9	(5)
6	33	(839)	24	(3.7)	XPS-6-2-33IC	XPS-6-2-33IC*3	XPS-6-4-33IC	XPS-6-4-33IC*3	3	9	(5)
7.5	40	(1016)	24	(3.7)	XPS-7.5-2-40IC	XPS-7.5-2-40IC*3	XPS-7.5-4-40IC	XPS-7.5-4-40IC*3	3	10	(5)
9	48	(1220)	24	(3.7)	XPS-9-2-48IC	XPS-9-2-48IC*3	XPS-9-4-48IC	XPS-9-4-48IC*3	3	11	(5)
12	64	(1626)	24	(3.7)		XPS-12-2-64IC*3	XPS-12-4-64IC	XPS-12-4-64IC*3	3	14	(7)
15	79	(2007)	24	(3.7)		XPS-15-2-79IC*3	XPS-15-4-79IC	XPS-15-4-79IC*3	3	16	(8)

For models or options not listed, please refer to our "Quick Quote" on the back inside cover or consult factory.

To place your order or for technical support, please call TOLL FREE 877-399-HEAT (4328) or FAX 401-245-9331



**Screw Plug Heaters - Incoloy Sheathed Elements**

**2 1/2" NPT**  
**S.S. Plug**

3 to 15 kW  
23-24 W/in<sup>2</sup>

**Watt Density 23-24 WSI**  
**120 Volt, Single Phase**  
**& 208 Volt, Single & Three Phase**

**Incoloy Sheathed Elements - 22-24 WSI**

kW	Immersion		Watt Density		120V	208V	208V	No. Ele	Est Weight	
	in	(mm)	W/in <sup>2</sup>	(W/cm <sup>2</sup> )	1 Phase	1 Phase	3 Phase		lb	(kg)
3	18	(458)	23	(3.6)	XRS-3-1-18IC	XRS-3-208-18IC	XRS-3-208-18IC*3	3	8	(4)
4.5	25	(635)	24	(3.7)	XRS-4.5-1-25IC	XRS-4.5-208-25IC	XRS-4.5-208-25IC*3	3	9	(5)
6	33	(839)	24	(3.7)		XRS-6-208-33IC	XRS-6-208-33IC*3	3	10	(5)
7.5	40	(1016)	24	(3.7)		XRS-7.5-208-40IC	XRS-7.5-208-40IC*3	3	11	(5)
9	48	(1220)	24	(3.7)		XRS-9-208-48IC	XRS-9-208-48IC*3	3	13	(6)
12	64	(1626)	24	(3.7)			XRS-12-208-64IC*3	3	15	(7)

**240 & 480 Volt, Single & Three Phase**

kW	Immersion		Watt Density		240V	240V	480V	480V	No. Ele	Est Weight	
	in	(mm)	W/in <sup>2</sup>	(W/cm <sup>2</sup> )	1 Phase	3 Phase	1 Phase	3 Phase		lb	(kg)
3	18	(458)	24	(3.7)	XRS-3-2-18IC	XRS-3-2-18IC*3	XRS-3-4-18IC	XRS-3-4-18IC*3	3	8	(4)
4.5	25	(635)	24	(3.7)	XRS-4.5-2-25IC	XRS-4.5-2-25IC*3	XRS-4.5-4-25IC	XRS-4.5-4-25IC*3	3	9	(5)
6	33	(839)	24	(3.7)	XRS-6-2-33IC	XRS-6-2-33IC*3	XRS-6-4-33IC	XRS-6-4-33IC*3	3	10	(5)
7.5	40	(1016)	24	(3.7)	XRS-7.5-2-40IC	XRS-7.5-2-40IC*3	XRS-7.5-4-40IC	XRS-7.5-4-40IC*3	3	11	(5)
9	48	(1220)	24	(3.7)	XRS-9-2-48IC	XRS-9-2-48IC*3	XRS-9-4-48IC	XRS-9-4-48IC*3	3	13	(6)
12	64	(1626)	24	(3.7)		XRS-12-2-64IC*3	XRS-12-4-64IC	XRS-12-4-64IC*3	3	15	(7)
15	79	(2007)	24	(3.7)		XRS-15-2-79IC*3	XRS-15-4-79IC	XRS-15-4-79IC*3	3	17	(8)

**3" NPT**  
**S.S. Plug**

6 to 30 kW  
23-24 W/in<sup>2</sup>

**Watt Density 23-24 WSI**  
**120 Volt, Single Phase**  
**& 208 Volt, Single & Three Phase**

kW	Immersion		Watt Density		120V	208V	208V	No. Ele	Est Weight	
	in	(mm)	W/in <sup>2</sup>	(W/cm <sup>2</sup> )	1 Phase	1 Phase	3 Phase		lb	(kg)
6	18	(458)	23	(3.6)	XCS-6-1-18IC+2	XCS-6-208-18IC	XCS-6-208-18IC*3	6	13	(6)
9	25	(635)	24	(3.7)	XCS-9-1-25IC+2	XCS-9-208-25IC	XCS-9-208-25IC*3	6	15	(7)
12	33	(839)	24	(3.7)		XCS-12-208-33IC+2	XCS-12-208-33IC*3	6	17	(8)
15	40	(1016)	24	(3.7)		XCS-15-208-40IC+2	XCS-15-208-40IC*3	6	20	(10)
18	48	(1220)	24	(3.7)		XCS-18-208-48IC+2	XCS-18-208-48IC*3+2	6	22	(10)

**240 & 480 Volt, Single & Three Phase**

kW	Immersion		Watt Density		240V	240V	480V	480V	No. Ele	Est Weight	
	in	(mm)	W/in <sup>2</sup>	(W/cm <sup>2</sup> )	1 Phase	3 Phase	1 Phase	3 Phase		lb	(kg)
6	18	(458)	23	(3.6)	XCS-6-2-18IC	XCS-6-2-18IC*3	XCS-6-4-18IC	XCS-6-4-18IC*3	6	13	(6)
9	25	(635)	24	(3.7)	XCS-9-2-25IC	XCS-9-2-25IC*3	XCS-9-4-25IC	XCS-9-4-25IC*3	6	15	(7)
12	33	(839)	24	(3.7)	XCS-12-2-33IC+2	XCS-12-2-33IC*3	XCS-12-4-33IC	XCS-12-4-33IC*3	6	17	(8)
15	40	(1016)	24	(3.7)	XCS-15-2-40IC+2	XCS-15-2-40IC*3	XCS-15-4-40IC	XCS-15-4-40IC*3	6	20	(10)
18	48	(1220)	24	(3.7)	XCS-18-2-48IC+2	XCS-18-2-48IC*3	XCS-18-4-48IC	XCS-18-4-48IC*3	6	22	(10)
24	64	(1626)	24	(3.7)		XCS-24-2-64IC*3+2	XCS-24-4-64IC+2	XCS-24-4-64IC*3	6	27	(13)
30	79	(2007)	24	(3.7)		XCS-30-2-79IC*3+2	XCS-30-4-79IC+2	XCS-30-4-79IC*3	6	32	(15)

For models or options not listed, please refer to our "Quick Quote" on the back inside cover or consult factory.

To place your order or for technical support, please call TOLL FREE 877-399-HEAT (4328) or FAX 401-245-9331



**Screw Plug Heaters - Incoloy Sheathed Elements**

**Typical Applications for  
Incoloy Sheathed Elements  
47-55 WSI**

- Process Water
- Deionized Water (Passivated)
- Potable Water

The models listed on these pages do not have thermostats, but are available with thermostats. A thermowell is standard in the design of the heaters listed in this catalog to allow for a thermostat/temperature sensing device.

To add a thermostat with a 60° - 250° F range, replace: **X** in model number with **2-**. A heater ordered with a thermostat will be supplied with a high profile terminal enclosure.

**2" NPT  
S.S. Plug**

**2 to 18 kW  
47-51 W/in<sup>2</sup>**

**Watt Density 47-51 WSI  
120 Volt, Single Phase  
& 208 Volt, Single & Three Phase**

kW	Immersion		Watt Density		120V	208V	208V	No. Ele	Est Weight	
	in	(mm)	W/in <sup>2</sup>	(W/cm <sup>2</sup> )	1 Phase	1 Phase	3 Phase		lb	(kg)
2	9	(229)	51	(7.9)	XPS-2-1-9IC	XPS-2-208-9IC		2	5	(3)
3	13	(331)	49	(7.6)	XPS-3-1-13IC	XPS-3-208-13IC		2	5	(3)
3	9	(229)	51	(7.9)	XPS-3-1-9IC	XPS-3-208-9IC	XPS-3-208-9IC*3	3	6	(3)
4	17.5	(445)	47	(7.3)	XPS-4-1-17.5IC	XPS-4-208-17.5IC		2	6	(3)
4.5	13	(331)	49	(7.6)	XPS-4.5-1-13IC	XPS-4.5-208-13IC	XPS-4.5-208-13IC*3	3	6	(3)
5	20	(508)	51	(7.9)	XPS-5-1-20IC	XPS-5-208-20IC		2	6	(3)
6	25	(635)	48	(7.4)		XPS-6-208-25IC		2	7	(4)
6	17.5	(445)	47	(7.3)		XPS-6-208-17.5IC	XPS-6-208-17.5IC*3	3	7	(4)
7.5	20	(508)	51	(7.9)		XPS-7.5-208-20IC	XPS-7.5-208-20IC*3	3	7	(4)
8	32	(813)	49	(7.6)		XPS-8-208-32IC		2	7	(4)
9	25	(635)	48	(7.4)		XPS-9-208-25IC	XPS-9-208-25IC*3	3	8	(4)
12	32	(813)	49	(7.6)			XPS-12-208-32IC*3	3	9	(5)
15	40	(1016)	48	(7.4)			XPS-15-208-40IC*3	3	10	(5)

**240 & 480 Volt, Single & Three Phase**

kW	Immersion		Watt Density		240V	240V	480V	480V	No. Ele	Est Weight	
	in	(mm)	W/in <sup>2</sup>	(W/cm <sup>2</sup> )	1 Phase	3 Phase	1 Phase	3 Phase		lb	(kg)
2	9	(229)	51	(7.9)	XPS-2-2-9IC		XPS-2-4-9IC		2	5	(3)
3	13	(331)	49	(7.6)	XPS-3-2-13IC		XPS-3-4-13IC		2	5	(3)
3	9	(229)	51	(7.9)	XPS-3-2-9IC	XPS-3-2-9IC*3	XPS-3-4-9IC	XPS-3-4-9IC*3	3	6	(3)
4	17.5	(445)	47	(7.3)	XPS-4-2-17.5IC		XPS-4-4-17.5IC		2	6	(3)
4.5	13	(331)	49	(7.6)	XPS-4.5-2-13IC	XPS-4.5-2-13IC*3	XPS-4.5-4-13IC	XPS-4.5-4-13IC*3	3	6	(3)
5	20	(508)	51	(7.9)	XPS-5-2-20IC		XPS-5-4-20IC		2	6	(3)
6	25	(635)	48	(7.4)	XPS-6-2-25IC		XPS-6-4-25IC		2	7	(4)
6	17.5	(445)	47	(7.3)	XPS-6-2-17.5IC	XPS-6-2-17.5IC*3	XPS-6-4-17.5IC	XPS-6-4-17.5IC*3	3	7	(4)
7.5	20	(508)	51	(7.9)	XPS-7.5-2-20IC	XPS-7.5-2-20IC*3	XPS-7.5-4-20IC	XPS-7.5-4-20IC*3	3	7	(4)
8	32	(813)	49	(7.6)	XPS-8-2-32IC		XPS-8-4-32IC		2	7	(4)
9	25	(635)	48	(7.4)	XPS-9-2-25IC	XPS-9-2-25IC*3	XPS-9-4-25IC	XPS-9-4-25IC*3	3	8	(4)
10	40	(1016)	48	(7.4)	XPS-10-2-40IC		XPS-10-4-40IC		2	8	(4)
12	48	(1220)	48	(7.4)			XPS-12-4-48IC		2	9	(5)
12	32	(813)	49	(7.6)		XPS-12-2-32IC*3	XPS-12-4-32IC	XPS-12-4-32IC*3	3	9	(5)
15	40	(1016)	48	(7.4)		XPS-15-2-40IC*3	XPS-15-4-40IC	XPS-15-4-40IC*3	3	10	(5)
18	48	(1220)	48	(7.4)		XPS-18-2-48IC*3	XPS-18-4-48IC	XPS-18-4-48IC*3	3	11	(5)

For models or options not listed, please refer to our "Quick Quote" on the back inside cover or consult factory.

To place your order or for technical support, please call TOLL FREE 877-399-HEAT (4328) or FAX 401-245-9331



## Screw Plug Heaters - Incoloy Sheathed Elements

**2 1/2" NPT**  
**S.S. Plug**

**3 to 18 kW**  
**47-51 W/in<sup>2</sup>**

**Watt Density 47-51 WSI**  
**120 Volt, Single Phase**  
**& 208 Volt, Single & Three Phase**

**Incoloy Sheathed Elements - 47-55 WSI**

kW	Immersion		Watt Density		120V	208V	208V	No.	Est Weight	
	in	(mm)	W/in <sup>2</sup>	(W/cm <sup>2</sup> )	1 Phase	1 Phase	3 Phase		Ele	lb
3	9	(229)	51	(7.9)	XRS-3-1-9IC	XRS-3-208-9IC	XRS-3-208-9IC*3	3	7	(4)
4.5	13	(331)	49	(7.6)	XRS-4.5-1-13IC	XRS-4.5-208-13IC	XRS-4.5-208-13IC*3	3	7	(4)
6	17.5	(445)	47	(7.3)		XRS-6-208-17.5IC	XRS-6-208-17.5IC*3	3	8	(4)
7.5	20	(508)	51	(7.9)		XRS-7.5-208-20IC	XRS-7.5-208-20IC*3	3	8	(4)
9	25	(635)	48	(7.4)		XRS-9-208-25IC	XRS-9-208-25IC*3	3	9	(5)
12	32	(813)	49	(7.6)			XRS-12-208-32IC*3	3	10	(5)
15	40	(1016)	48	(7.4)			XRS-15-208-40IC*3	3	11	(5)

### 240 & 480 Volt, Single & Three Phase

kW	Immersion		Watt Density		240V	240V	480V	480V	No.	Est Weight	
	in	(mm)	W/in <sup>2</sup>	(W/cm <sup>2</sup> )	1 Phase	3 Phase	1 Phase	3 Phase		Ele	lb
3	9	(229)	51	(7.9)	XRS-3-2-9IC	XRS-3-2-9IC*3	XRS-3-4-9IC	XRS-3-4-9IC*3	3	7	(4)
4.5	13	(331)	49	(7.6)	XRS-4.5-2-13IC	XRS-4.5-2-13IC*3	XRS-4.5-4-13IC	XRS-4.5-4-13IC*3	3	7	(4)
6	17.5	(445)	47	(7.3)	XRS-6-2-17.5IC	XRS-6-2-17.5IC*3	XRS-6-4-17.5IC	XRS-6-4-17.5IC*3	3	8	(4)
7.5	20	(508)	51	(7.9)	XRS-7.5-2-20IC	XRS-7.5-2-20IC*3	XRS-7.5-4-20IC	XRS-7.5-4-20IC*3	3	8	(4)
9	25	(635)	48	(7.4)	XRS-9-2-25IC	XRS-9-2-25IC*3	XRS-9-4-25IC	XRS-9-4-25IC*3	3	9	(5)
12	32	(813)	49	(7.6)		XRS-12-2-32IC*3	XRS-12-4-32IC	XRS-12-4-32IC*3	3	10	(5)
15	40	(1016)	48	(7.4)		XRS-15-2-40IC*3	XRS-15-4-40IC	XRS-15-4-40IC*3	3	11	(5)
18	48	(1220)	48	(7.4)		XRS-18-2-48IC*3	XRS-18-4-48IC	XRS-18-4-48IC*3	3	13	(6)

**3" NPT**  
**S.S. Plug**

**6 to 36 kW**  
**47-55 W/in<sup>2</sup>**

**Watt Density 47-55 WSI**  
**120 Volt, Single Phase**  
**& 208 Volt, Single & Three Phase**

kW	Immersion		Watt Density		120V	208V	208V	No.	Est Weight	
	in	(mm)	W/in <sup>2</sup>	(W/cm <sup>2</sup> )	1 Phase	1 Phase	3 Phase		Ele	lb
6	9	(229)	51	(7.9)	XCS-6-1-9IC+2	XCS-6-208-9IC	XCS-6-208-9IC*3	6	10	(5)
9	13	(331)	49	(7.6)	XCS-9-1-13IC+2	XCS-9-208-13IC	XCS-9-208-13IC*3	6	11	(5)
12	17.5	(445)	47	(7.3)		XCS-12-208-17.5IC+2	XCS-12-208-17.5IC*3	6	13	(6)
15	20	(508)	51	(7.9)		XCS-15-208-20IC+2	XCS-15-208-20IC*3	6	14	(7)
18	25	(635)	48	(7.4)		XCS-18-208-25IC+2	XCS-18-208-25IC*3+2	6	15	(7)
24	32	(813)	49	(7.6)			XCS-24-208-32IC*3+2	6	17	(8)
30	40	(1016)	48	(7.4)			XCS-30-208-40IC*3+2	6	20	(10)

### 240 & 480 Volt, Single & Three Phase

kW	Immersion		Watt Density		240V	240V	480V	480V	No.	Est Weight	
	in	(mm)	W/in <sup>2</sup>	(W/cm <sup>2</sup> )	1 Phase	3 Phase	1 Phase	3 Phase		Ele	lb
6	9	(229)	55	(8.5)	XCS-6-2-9IC	XCS-6-2-9IC*3	XCS-6-4-9IC	XCS-6-4-9IC*3	6	10	(5)
9	13	(331)	52	(8.1)	XCS-9-2-13IC	XCS-9-2-13IC*3	XCS-9-4-13IC	XCS-9-4-13IC*3	6	11	(5)
12	17.5	(445)	47	(7.3)	XCS-12-2-17.5IC+2	XCS-12-2-17.5IC*3	XCS-12-4-17.5IC	XCS-12-4-17.5IC*3	6	13	(6)
15	20	(508)	50	(7.8)	XCS-15-2-20IC+2	XCS-15-2-20IC*3	XCS-15-4-20IC	XCS-15-4-20IC*3	6	14	(7)
18	25	(635)	47	(7.3)	XCS-18-2-25IC+2	XCS-18-2-25IC*3	XCS-18-4-25IC	XCS-18-4-25IC*3	6	15	(7)
24	32	(813)	49	(7.6)		XCS-24-2-32IC*3+2	XCS-24-4-32IC+2	XCS-24-4-32IC*3	6	17	(8)
30	40	(1016)	48	(7.4)		XCS-30-2-40IC*3+2	XCS-30-4-40IC+2	XCS-30-4-40IC*3	6	20	(10)
36	48	(1220)	48	(7.4)		XCS-36-2-48IC*3+2	XCS-36-4-48IC+2	XCS-36-4-48IC*3	6	22	(10)

To place your order or for technical support, please call TOLL FREE 877-399-HEAT (4328) or FAX 401-245-9331





## Screw Plug Heaters - Stainless Sheathed Elements

### Typical Applications for Stainless Sheathed Elements 47-51 WSI

- Deionized Water (Passivated)
- Mild Alkaline Solutions

The models listed on these pages do not have thermostats, but are available with thermostats. A thermowell is standard in the design of the heaters listed in this catalog to allow for a thermostat/temperature sensing device.

To add a thermostat with a 60° - 250° F range, replace: **X** in model number with **2-**. A heater ordered with a thermostat will be supplied with a high profile terminal enclosure.

**2" NPT  
S.S. Plug**

**2 to 18 kW  
47-51 W/in<sup>2</sup>**

**Watt Density 47-51 WSI  
120 Volt, Single Phase  
& 208 Volt, Single & Three Phase**

kW	Immersion		Watt Density		120V	208V	208V	No. Ele
	in	(mm)	W/in <sup>2</sup>	(W/cm <sup>2</sup> )	1 Phase	1 Phase	3 Phase	
2	9	(229)	51	(7.9)	XPS-2-1-9SS	XPS-2-208-9SS		2
3	13	(331)	49	(7.6)	XPS-3-1-13SS	XPS-3-208-13SS		2
3	9	(229)	51	(7.9)	XPS-3-1-9SS	XPS-3-208-9SS	XPS-3-208-9SS*3	3
4	17.5	(445)	47	(7.3)	XPS-4-1-17.5SS	XPS-4-208-17.5SS		2
4.5	13	(331)	49	(7.6)	XPS-4.5-1-13SS	XPS-4.5-208-13SS	XPS-4.5-208-13SS*3	3
5	20	(508)	51	(7.9)	XPS-5-1-20SS	XPS-5-208-20SS		2
6	25	(635)	48	(7.4)		XPS-6-208-25SS		2
6	17.5	(445)	47	(7.3)		XPS-6-208-17.5SS	XPS-6-208-17.5SS*3	3
7.5	20	(508)	51	(7.9)		XPS-7.5-208-20SS	XPS-7.5-208-20SS*3	3
8	32	(813)	49	(7.6)		XPS-8-208-32SS		2
9	25	(635)	48	(7.4)		XPS-9-208-25SS	XPS-9-208-25SS*3	3
12	32	(813)	49	(7.6)			XPS-12-208-32SS*3	3
15	40	(1016)	48	(7.4)			XPS-15-208-40SS*3	3

### 240 & 480 Volt, Single & Three Phase

kW	Immersion		Watt Density		240V	240V	480V	480V	No. Ele
	in	(mm)	W/in <sup>2</sup>	(W/cm <sup>2</sup> )	1 Phase	3 Phase	1 Phase	3 Phase	
2	9	(229)	51	(7.9)	XPS-2-2-9SS		XPS-2-4-9SS		2
3	13	(331)	49	(7.6)	XPS-3-2-13SS		XPS-3-4-13SS		2
3	9	(229)	51	(7.9)	XPS-3-2-9SS	XPS-3-2-9SS*3	XPS-3-4-9SS	XPS-3-4-9SS*3	3
4	17.5	(445)	47	(7.3)	XPS-4-2-17.5SS		XPS-4-4-17.5SS		2
4.5	13	(331)	49	(7.6)	XPS-4.5-2-13SS	XPS-4.5-2-13SS*3	XPS-4.5-4-13SS	XPS-4.5-4-13SS*3	3
5	20	(508)	51	(7.9)	XPS-5-2-20SS		XPS-5-4-20SS		2
6	25	(635)	48	(7.4)	XPS-6-2-25SS		XPS-6-4-25SS		2
6	17.5	(445)	47	(7.3)	XPS-6-2-17.5SS	XPS-6-2-17.5SS*3	XPS-6-4-17.5SS	XPS-6-4-17.5SS*3	3
7.5	20	(508)	51	(7.9)	XPS-7.5-2-20SS	XPS-7.5-2-20SS*3	XPS-7.5-4-20SS	XPS-7.5-4-20SS*3	3
8	32	(813)	49	(7.6)	XPS-8-2-32SS		XPS-8-4-32SS		2
9	25	(635)	48	(7.4)	XPS-9-2-25SS	XPS-9-2-25SS*3	XPS-9-4-25SS	XPS-9-4-25SS*3	3
10	40	(1016)	48	(7.4)	XPS-10-2-40SS		XPS-10-4-40SS		2
12	48	(1220)	48	(7.4)			XPS-12-4-48SS		2
12	32	(813)	49	(7.6)		XPS-12-2-32SS*3	XPS-12-4-32SS	XPS-12-4-32SS*3	3
15	40	(1016)	48	(7.4)		XPS-15-2-40SS*3	XPS-15-4-40SS	XPS-15-4-40SS*3	3
18	48	(1220)	48	(7.4)		XPS-18-2-48SS*3	XPS-18-4-48SS	XPS-18-4-48SS*3	3

For models or options not listed, please refer to our "Quick Quote" on the back inside cover or consult factory.

To place your order or for technical support, please call TOLL FREE 877-399-HEAT (4328) or FAX 401-245-9331

or check our web site: [www.warrenonline.com](http://www.warrenonline.com)



**Screw Plug Heaters - Stainless Sheathed Elements**

**2 1/2" NPT  
S.S. Plug**

**3 to 18 kW  
47-51 W/in<sup>2</sup>**

**Watt Density 47-51 WSI  
120 Volt, Single Phase  
& 208 Volt, Single & Three Phase**

**Stainless Sheathed Elements - 47-51 WSI**

kW	Immersion		Watt Density		120V	208V	208V	No. Ele	Est Weight	
	in	(mm)	W/in <sup>2</sup>	(W/cm <sup>2</sup> )	1 Phase	1 Phase	3 Phase		lb	(kg)
3	9	(229)	51	(7.9)	XRS-3-1-9SS	XRS-3-208-9SS	XRS-3-208-9SS*3	3	7	(4)
4.5	13	(331)	49	(7.6)	XRS-4.5-1-13SS	XRS-4.5-208-13SS	XRS-4.5-208-13SS*3	3	7	(4)
6	17.5	(445)	47	(7.3)		XRS-6-208-17.5SS	XRS-6-208-17.5SS*3	3	8	(4)
7.5	20	(508)	51	(7.9)		XRS-7.5-208-20SS	XRS-7.5-208-20SS*3	3	8	(4)
9	25	(635)	48	(7.4)		XRS-9-208-25SS	XRS-9-208-25SS*3	3	9	(5)
12	32	(813)	49	(7.6)			XRS-12-208-32SS*3	3	10	(5)
15	40	(1016)	48	(7.4)			XRS-15-208-40SS*3	3	11	(5)

**240 & 480 Volt, Single & Three Phase**

kW	Immersion		Watt Density		240V	240V	480V	480V	No. Ele	Est Weight	
	in	(mm)	W/in <sup>2</sup>	(W/cm <sup>2</sup> )	1 Phase	3 Phase	1 Phase	3 Phase		lb	(kg)
3	9	(229)	51	(7.9)	XRS-3-2-9SS	XRS-3-2-9SS*3	XRS-3-4-9SS	XRS-3-4-9SS*3	3	7	(4)
4.5	13	(331)	49	(7.6)	XRS-4.5-2-13SS	XRS-4.5-2-13SS*3	XRS-4.5-4-13SS	XRS-4.5-4-13SS*3	3	7	(4)
6	17.5	(445)	47	(7.3)	XRS-6-2-17.5SS	XRS-6-2-17.5SS*3	XRS-6-4-17.5SS	XRS-6-4-17.5SS*3	3	8	(4)
7.5	20	(508)	51	(7.9)	XRS-7.5-2-20SS	XRS-7.5-2-20SS*3	XRS-7.5-4-20SS	XRS-7.5-4-20SS*3	3	8	(4)
9	25	(635)	48	(7.4)	XRS-9-2-25SS	XRS-9-2-25SS*3	XRS-9-4-25SS	XRS-9-4-25SS*3	3	9	(5)
12	32	(813)	49	(7.6)		XRS-12-2-32SS*3	XRS-12-4-32SS	XRS-12-4-32SS*3	3	10	(5)
15	40	(1016)	48	(7.4)		XRS-15-2-40SS*3	XRS-15-4-40SS	XRS-15-4-40SS*3	3	11	(5)
18	48	(1220)	48	(7.4)		XRS-18-2-48SS*3	XRS-18-4-48SS	XRS-18-4-48SS*3	3	13	(6)

**3" NPT  
S.S. Plug**

**6 to 30 kW  
47-51 W/in<sup>2</sup>**

**Watt Density 47-51 WSI  
120 Volt, Single Phase  
& 208 Volt, Single & Three Phase**

kW	Immersion		Watt Density		120V	208V	208V	No. Ele	Est Weight	
	in	(mm)	W/in <sup>2</sup>	(W/cm <sup>2</sup> )	1 Phase	1 Phase	3 Phase		lb	(kg)
6	9	(229)	51	(7.9)	XCS-6-1-9SS+2	XCS-6-208-9SS	XCS-6-208-9SS*3	6	10	(5)
9	13	(331)	49	(7.6)	XCS-9-1-13SS+2	XCS-9-208-13SS	XCS-9-208-13SS*3	6	11	(5)
12	17.5	(445)	47	(7.3)		XCS-12-208-17.5SS+2	XCS-12-208-17.5SS*3	6	13	(6)
15	20	(508)	51	(7.9)		XCS-15-208-20SS+2	XCS-15-208-20SS*3	6	14	(7)
18	25	(635)	48	(7.4)		XCS-18-208-25SS+2	XCS-18-208-25SS*3+2	6	15	(7)
24	32	(813)	49	(7.6)			XCS-24-208-32SS*3+2	6	17	(8)
30	40	(1016)	48	(7.4)			XCS-30-208-40SS*3+2	6	20	(10)

**240 & 480 Volt, Single & Three Phase**

kW	Immersion		Watt Density		240V	240V	480V	480V	No. Ele	Est Weight	
	in	(mm)	W/in <sup>2</sup>	(W/cm <sup>2</sup> )	1 Phase	3 Phase	1 Phase	3 Phase		lb	(kg)
6	9	(229)	51	(7.9)	XCS-6-2-9SS	XCS-6-2-9SS*3	XCS-6-4-9SS	XCS-6-4-9SS*3	6	10	(5)
9	13	(331)	49	(7.6)	XCS-9-2-13SS	XCS-9-2-13SS*3	XCS-9-4-13SS	XCS-9-4-13SS*3	6	11	(5)
12	17.5	(445)	47	(7.3)	XCS-12-2-17.5SS+2	XCS-12-2-17.5SS*3	XCS-12-4-17.5SS	XCS-12-4-17.5SS*3	6	13	(6)
15	20	(508)	51	(7.9)	XCS-15-2-20SS+2	XCS-15-2-20SS*3	XCS-15-4-20SS	XCS-15-4-20SS*3	6	14	(7)
18	25	(635)	48	(7.4)	XCS-18-2-25SS+2	XCS-18-2-25SS*3	XCS-18-4-25SS	XCS-18-4-25SS*3	6	15	(7)
24	32	(813)	49	(7.6)		XCS-24-2-32SS*3+2	XCS-24-4-32SS+2	XCS-24-4-32SS*3	6	17	(8)
30	40	(1016)	48	(7.4)		XCS-30-2-40SS*3+2	XCS-30-4-40SS+2	XCS-30-4-40SS*3	6	20	(10)
36	48	(1220)	48	(7.4)		XCS-36-2-48SS*3+2	XCS-36-4-48SS+2	XCS-36-4-48SS*3	6	22	(10)

To place your order or for technical support, please call TOLL FREE 877-399-HEAT (4328) or FAX 401-245-9331



## Thermostat/Thermowell Information

*A specific wiring instruction sheet is provided with each heater.*

All heaters listed in this catalog are shown without thermostats, but do have integral thermowells. All heaters without thermostats and/or thermocouples are provided with low profile terminal enclosures unless otherwise requested.

**However, all heaters are available with our standard SPST Thermostats. Other ranges and DPST thermostats are also available. Please advise factory of your request.**

Remote mount thermostats with thermowells also are available, as well as manual reset cutouts, thermocouples, pilot lights, and RTD's. Specify enclosure type, minimum capillary length, and thermowell material and length when ordering. Please consult our Applications Engineers for further information.

### To Add Thermostat:

Please note: Thermostats are not a fail safe device. Users should install adequate controls or safety devices to control failure.

*Replace existing prefix "X" in our model number and add prefix:*

- |                                   |  |
|-----------------------------------|--|
| <b>1-</b> for 0° -100° F range    | <b>0° - 100° F Range SPST Thermostat (-18 – 38° C)</b>   |
| <b>2-</b> for 60° - 250° F range  | <b>60° - 250° F Range SPST Thermostat (16 – 121° C)</b>  |
| <b>3-</b> for 175° - 550° F range | <b>175° - 550° F Range SPST Thermostat (79 – 288° C)</b> |

*For example 1-GS-6-2-22C is a model with a SPST thermostat with 0° -100° F range*

## Thermocouples

For applications that require a more accurate temperature sensing device than a thermostat, a built in thermocouple such as Type "J" or "K" can be provided. A thermocouple only senses temperature and must be used in conjunction with a controller (provided by another source). A thermocouple can be purchased with either a grounded or ungrounded junction and you need to inform us which type you need for your controller. Warren Electric uses the ungrounded type thermocouples as a standard. When using a thermocouple you need to have a separate conduit opening for the thermocouple wires.

The Type "J" thermocouples are conductors of iron and constantan with a maximum operating temperature of 1400° F (normally used for applications up to 800° F). It is normally used in liquid applications.

The Type "K" thermocouples are conductors of alumel and chromel with a maximum operating temperature of 2300° F (normally used for applications over 800° F). It is normally used in gas applications

### To Add Thermocouple

*Replace existing prefix "X" and add prefix*

**5-** for Thermocouple

*For example: 5-GS-6-2-22C is a model with a thermocouple*

## RTD'S

### To Add RTD

For even more accurate temperature sensing than a thermocouple, a RTD is recommended. RTD's are available with two, three and four wires for different types of applications. For further information, feel free to contact our Application Engineers.

*Replace existing prefix "X" and add prefix*

**7-** for RTD

*e.g. 7-GS-6-2-22C is a model with a RTD*

*An integral thermostat, if provided, is designed for temperature control service only. A thermostat is not fail safe. It should not be used for temperature limiting duty. The system designer is responsible to install adequate back-up controls and safety devices. Where the consequences of failure could result in bodily or property injury, back-up controls are essential.*



## Casings & Assemblies

Standard and custom design casings are available for all screw plug models. All casings can be manufactured with virtually any type and size of inlet, outlet, drain, and/or vent to suit your application. Pressure ratings for casings for screw plug heaters from 150 to 1500 PSIG (including ASME certification) are available. High temperature insulation and jacketing are also available for all casing models as requested. Please submit details to our Applications Engineer for quote.

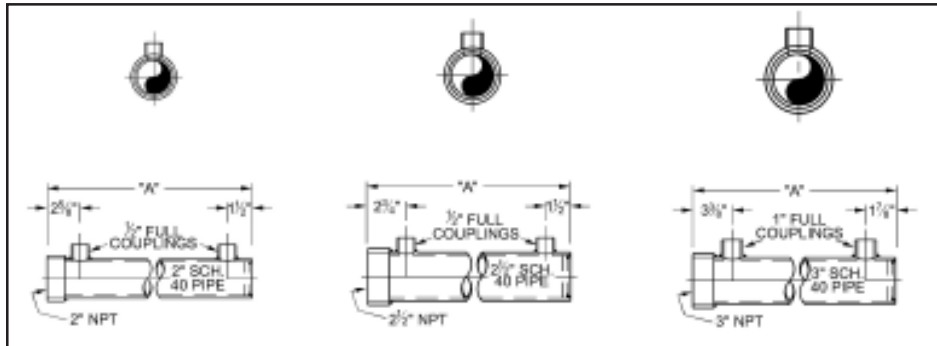

2" NPT Casings			2-1/2" NPT Casings			3" NPT Casings		
Max. Heater Imm. Length (in.)	Casing Model Number	"A" (in.)	Max. Heater Imm. Length (in.)	Casing Model Number	"A" (in.)	Max. Heater Imm. Length (in.)	Casing Model Number	"A" (in.)
6	SP-S-6	7 1/2	6	SP-R-6	8	6	SP-C-6	8
8	SP-S-8	9 1/2	8	SP-R-8	10	8	SP-C-8	10
10	SP-S-10	11 1/2	10	SP-R-10	12	10	SP-C-10	12
12	SP-S-12	13 1/2	12	SP-R-12	14	12	SP-C-12	14
14	SP-S-14	15 1/2	14	SP-R-14	16	14	SP-C-14	16
16	SP-S-16	17 1/2	16	SP-R-16	18	16	SP-C-16	18
18	SP-S-18	19 1/2	18	SP-R-18	20	18	SP-C-18	20
20	SP-S-20	21 1/2	20	SP-R-20	22	20	SP-C-20	22
22	SP-S-22	23 1/2	22	SP-R-22	24	22	SP-C-22	24
24	SP-S-24	25 1/2	24	SP-R-24	26	24	SP-C-24	26
26	SP-S-26	27 1/2	26	SP-R-26	28	26	SP-C-26	28
28	SP-S-28	29 1/2	28	SP-R-28	30	28	SP-C-28	30
30	SP-S-30	31 1/2	30	SP-R-30	32	30	SP-C-30	32
32	SP-S-32	33 1/2	32	SP-R-32	34	32	SP-C-32	34
34	SP-S-34	35 1/2	34	SP-R-34	36	34	SP-C-34	36
36	SP-S-36	37 1/2	36	SP-R-36	38	36	SP-C-36	38
38	SP-S-38	39 1/2	38	SP-R-38	40	38	SP-C-38	40
40	SP-S-40	41 1/2	40	SP-R-40	42	40	SP-C-40	42
42	SP-S-42	43 1/2	42	SP-R-42	44	42	SP-C-42	44
44	SP-S-44	45 1/2	44	SP-R-44	46	44	SP-C-44	46
46	SP-S-46	47 1/2	46	SP-R-46	48	46	SP-C-46	48
48	SP-S-48	49 1/2	48	SP-R-48	50	48	SP-C-48	50
50	SP-S-50	51 1/2	50	SP-R-50	52	50	SP-C-50	52
52	SP-S-52	53 1/2	52	SP-R-52	54	52	SP-C-52	54
54	SP-S-54	55 1/2	54	SP-R-54	56	54	SP-C-54	56
56	SP-S-56	57 1/2	56	SP-R-56	58	56	SP-C-56	58
58	SP-S-58	59 1/2	58	SP-R-58	60	58	SP-C-58	60
60	SP-S-60	61 1/2	60	SP-R-60	62	60	SP-C-60	62
62	SP-S-62	63 1/2	62	SP-R-62	64	62	SP-C-62	64
64	SP-S-64	65 1/2	64	SP-R-64	66	64	SP-C-64	66
66	SP-S-66	67 1/2	66	SP-R-66	68	66	SP-C-66	68
68	SP-S-68	69 1/2	68	SP-R-68	70	68	SP-C-68	70
70	SP-S-70	71 1/2	70	SP-R-70	72	70	SP-C-70	72
72	SP-S-72	73 1/2	72	SP-R-72	74	72	SP-C-72	74
74	SP-S-74	75 1/2	74	SP-R-74	76	74	SP-C-74	76
76	SP-S-76	77 1/2	76	SP-R-76	78	76	SP-C-76	78
78	SP-S-78	79 1/2	78	SP-R-78	80	78	SP-C-78	80
80	SP-S-80	81 1/2	80	SP-R-80	82	80	SP-C-80	82

## Insulated and Jacketed Casing Assemblies

All Warren Electric casings are available insulated and jacketed for high temperature applications where process heat losses are to be kept at a minimum. Casings are furnished with calcium silicate insulation and steel jackets.

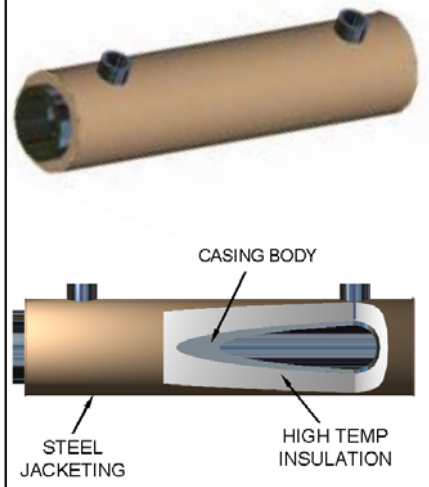



## Terminal Enclosures

Heavy duty general purpose terminal enclosures are standard with Screw Plug Heaters. Warren Electric's general purpose terminal enclosure provides superior mechanical protection for your heater's wiring, terminals, and thermostat. Our general purpose terminal enclosure is constructed from heavy gauge cast aluminum, as opposed to a drawn "tin can" style often seen with other brands.

Models listed in this catalog are without thermostats and are low profile terminal enclosures. A heater ordered with a thermostat will be supplied with a high profile terminal enclosure, but any heater can be ordered with a high profile terminal enclosure.

Should you require additional environmental protection, any heater can be ordered with Explosion Resistant/Weather Resistant terminal enclosures. All are manufactured with materials chosen to provide superior mechanical protection.

Alternate terminal enclosures are available for those applications where economy is paramount and the need for mechanical and environmental protection of the terminals is less important. For further information on these options, please contact the factory.

### To Change Terminal Enclosure:

For dimensional and information on other terminal enclosures, see NEXT PAGE.

*For alternative enclosure, add suffix:*

- LT** Weather resistant
  - EP** Explosion-Resistant
  - EP/LT** Explosion/Weather-Resistant
  - HH** "Helmet Head"
- e.g. XGS-6-2-22C-LT*

Example: **XPS-4-2-51\*3**

Model Number with Weather-Resistant Terminal Enclosure Designation:

**XPS-4-2-51-LT\*3**

Note: Replace **LT** in above example with appropriate designation for other types shown below. If left blank a general purpose terminal enclosure will be provided. Please consult factory for other options.

Selection: No Designation = General Purpose (Low profile without Thermostat,  
High profile with Thermostat)

**LT** = Weather-Resistant: Dust and Moisture Resistant

**EP** = Explosion-Resistant: Dust and Vapor Resistant

**EP/LT** = Explosion-Resistant and Weather-Resistant

## "Helmet Head" Terminal Enclosures

**Please NOTE:** Warren Electric Corporation also has an optional unique terminal enclosure for screw plug heaters. "Helmet Head" Heaters are a compact, versatile screw plug design with a terminal









enclosure that makes installation in confined areas more manageable. This unique design offers benefits over conventional screw plugs such as compactness and superior resistance to mechanical impact. Please request our "[HH Series](#)" Brochure for more information.

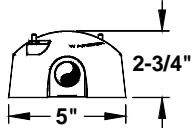
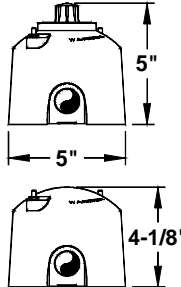

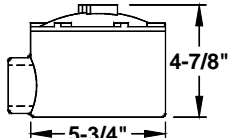

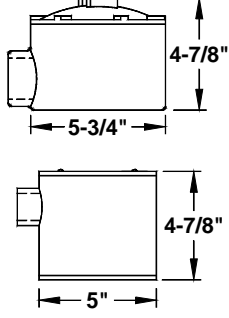
## Terminal Enclosures continued

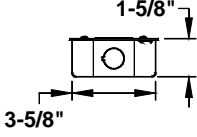
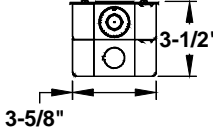
Enclosure	Without Thermostat	With Thermostat	Description
General Purpose			Type <b>NEMA 1</b> enclosure intended for use indoors, primarily to prevent accidental contact of personnel with the enclosed equipment. Used in areas where unusual service conditions do not exist.
Explosion-Resistant			Type <b>NEMA 7</b> enclosure intended for use indoors, where resistance to explosion is paramount.
Weather-Resistant			Type <b>NEMA 4</b> enclosure intended for indoor or outdoor use. Used primarily to provide a degree of protection against windblown dust and rain, splashing water, hose-directed water, and external ice formation.
"Helmet Head"	 <i>Dimensions vary by Screw plug Size</i>	 <i>Dimensions vary by Screw plug Size</i>	Rugged compact enclosure for indoor use to provide optimal protection from physical damage.
General Purpose Economy			Type <b>NEMA 1</b> enclosure intended for use indoors, primarily to prevent accidental contact of personnel with the enclosed equipment. Used where economy is paramount, in areas where unusual service conditions do not exist.

Consult our application engineers to ensure appropriate enclosure selection.

Please note: Dimensions shown are for reference only. Changes may be made at any time. Please consult factory.



## "Model Designation"

Warren Electric has established a model numbering system that is unique in that it allows you to indicate most specifications, such as wattage, voltage, flange size, immersion length, element sheath material, etc.

The following notes are an explanation of the chart below.

- 1 PRESSURE RATING:** The maximum pressure rating, except 150 PSI, is included in the model number. If no pressure rating is indicated, the pressure rating is 150 PSI.
- 2 TEMPERATURE CONTROL:** Temperature control designations are indicated. "X" signifies no control; "1" through "4" designate thermostat temperature ranges; "5" indicates the use of a thermocouple, "7" for a RTD. (The type of thermocouple is not included in the model number.)
- 3 FLANGE OR SCREW PLUG SIZE:** Flange or Screw Plug sizes are designated alphabetically.
- 4 FLANGE OR SCREW PLUG CONSTRUCTION:** Each basic heater type has its own one-letter designation. "S" for Screw Plug Heaters, "F" for Flanged Heaters, "J" for Jacketed Circulation Heaters, "T" for Over- the-side Immersion Heaters.
- 5 WATTAGE:** Indicates Kilowatt rating.
- 6 VOLTAGE:** Indicates nominal operating voltage. Voltages other than 120, 240, 480 and 550 volts are specified with a 3-digit voltage number.
- 7 IMMERSED LENGTH:** Indicated in inches.
- 8 ELEMENT SHEATH MATERIAL:** Indicates element sheath material. If no letter is indicated, the sheath material is Carbon Steel.
- 9 OPTIONAL MODIFICATIONS:** Options such as Explosion-Resistant and/or Weather-Resistant Terminal Enclosures, etc. are indicated in the model number.
- 10 PHASE:** Indicates 1 or 3 phase. If no number is indicated, single phase is furnished.

**X**      **C**      **F** - **5** - **2** - **14**      **C** - **EP**      **\*3**

**1**      **2**      **3**      **4**      **5**      **6**      **7**      **8**      **9**      **10**

1 PRESSURE RATING PSI	2 TEMPERATURE CONTROL	3 FLANGE OR SCREW PLUG SIZE	4 FLANGE/SCREW CONSTRUCTION TYPE	5 WATTAGE (KW)	6 VOLTAGE (VOLTS)	7 IMMERSED LENGTH (INCHES)	8 ELEMENT SHEATH	9 OPTIONS	10 PHASE
300 = 300 600 = 600 900 = 900  150 PSI Standard Not Indicated	X= No Thermostat 1 = 01°-100° F 2 = 60°-250° F 3 = 175°-550° F 4 = Other Ranges 5 = Thermocouple 7 = RTD A* = WE Fuel Oil B* = Preheater	A* A* B* B* F = 1" G = 1 1/4" P = 2" R = 2 1/2" C = 3" U = 4" W = 5" H = 6" K = 8" L = 10" M = 12" N = 14" T = 16" V = 18" E = 20" Y = 22" Z = 24"	F=Flange S=Screw Plug J=Jacketed T=Over-the-Side		1 = 120 2 = 240 4 = 480 5 = 550  Others (use full numbers)		C = Copper IC= Incoloy IL= Inconel SS= Stainless Steel  Steel = not indicated	LT = Weather Resistant EP = Explosion Resistant R = Removable Elements Y = Any other Specification	*3 = 3 phase  Single Phase = not indicated
* WEC Fuel Oil Heater Models - Special Industrial Flange and Thermostat for Residual Fuel Oils. Request Catalog. Used with A or B Types such as AD or BD and indicates WEC Fuel Oil Heater Thermostat with additional Interlock Control.		<p><b>Example: XCF-5-2-14C-EP*3</b></p> <p>The model number featured in the EXAMPLE is pressure rated 150 PSI with no temperature control. It has a 3" X 150 ANSI Steel Flange, with an output of 5 KW (at 240 Volt, 3 phase). The immersed length is 14 inches with copper elements and an explosion resistant terminal enclosure.</p> <p>(If the model in the example had a PSI rating other than 150 PSI, it would begin with the PSI rating. For example, if the model in the example is pressure rated 300 PSI, it would change the model number to 300-XCF-5-2-14C-EP*3.)</p>							

To place your order or for technical support, please call TOLL FREE 877-399-HEAT (4328) or FAX 401-245-9331



# Screw Plug Heater "Quick Quote"

**Warren Electric Corporation**

36 Franklin Street, PO Box 86, Warren, Rhode Island 02885-0086 U.S.A.  
TEL: 401 245-3700 FAX: 401 245-9331 www.warrenonline.com  
Toll Free: 1-877-399-HEAT (4328)

Date: \_\_\_\_\_

From: \_\_\_\_\_ Tel: (\_\_\_\_) \_\_\_\_ - \_\_\_\_\_ Fax: (\_\_\_\_) \_\_\_\_ - \_\_\_\_\_

Company: \_\_\_\_\_ Location #: \_\_\_\_\_

Address: \_\_\_\_\_ City: \_\_\_\_\_ State: \_\_\_\_\_ Zip: \_\_\_\_\_

<b>APPLICATION</b> <i>Please complete as much information as possible:</i>			
Quantity _____	<input type="checkbox"/> New Application	<input type="checkbox"/> Horizontally Mounted	<input type="checkbox"/> Vertically Mounted
	Replacement Model # _____		Manufacturer _____
<b>SCREW PLUG</b>			
Size:	<input type="checkbox"/> 1" <input type="checkbox"/> 1 1/4" <input type="checkbox"/> 1 1/2" <input type="checkbox"/> 2" <input type="checkbox"/> 2 1/2" <input type="checkbox"/> 3" NPT	Other: _____"	Size may be determined by application
Material:	<input type="checkbox"/> Steel <input type="checkbox"/> Stainless Steel <input type="checkbox"/> Brass/Bronze	<input type="checkbox"/> Other: _____	
<b>ELEMENT SHEATH</b>			
Material:	<input type="checkbox"/> Copper <input type="checkbox"/> Steel <input type="checkbox"/> Stainless Steel <input type="checkbox"/> Incoloy	<input type="checkbox"/> Other: _____	
<b>TECHNICAL REQUIREMENTS</b>			
Voltage:	Phase: <input type="checkbox"/> Single <input type="checkbox"/> Three	KW Required (IF KNOWN): _____	
Immersion Length:	Min _____" Max _____"	Operating Temperature: _____° F or _____° C	
Fluid/Gas to be Heated:		Watt Density:	WSI _____
<b>CONTROLS</b>			
Thermostat:	<input type="checkbox"/> None	<input type="checkbox"/> Other: _____° F or _____° C	Thermocouple:
	<input type="checkbox"/> 0° -- 100° F (-18° -- 38° C)	<input type="checkbox"/> 60° -- 250° F (16° -- 121° C)	Type "____"
	<input type="checkbox"/> 175° -- 550° F (79° -- 288° C)	Helmet Head will not accommodate integral thermostats.	<input type="checkbox"/> GND'D <input type="checkbox"/> Un-GND'D
			RTD: Resistance _____ Ω No. of Wires: _____
<b>TERMINAL ENCLOSURE</b>			
Type:	<input type="checkbox"/> General Purpose <input type="checkbox"/> Weather-Resistant	<input type="checkbox"/> Explosion-Resistant <input type="checkbox"/> Explosion/Weather-Resistant	<input type="checkbox"/> Economy <input type="checkbox"/> Helmet Head
<b>Please complete the following for sizing recommendations:</b>			
Volume of Fluid to be Heated: _____ Gallons	Tank Size: _____" Length x _____" Width x _____" Height or _____" Diameter x _____" Height or Length	Tank Top: <input type="checkbox"/> Open <input type="checkbox"/> Closed	
Desired Temperature to Maintain: _____° F or _____° C	<input type="checkbox"/> Horizontal Tank <input type="checkbox"/> Vertical Tank	Tank Insulation: <input type="checkbox"/> None <input type="checkbox"/> 1" <input type="checkbox"/> 2" <input type="checkbox"/> Other _____"	
Outside Ambient Temperature: (worst case): _____° F or _____° C	Recommendation will be provided using the above parameters assuming fluid is in a static state. <b>If the fluid is continuously circulating out of the tank, provide a flow rate in gallons per hour or gallons per minute.</b>		
Initial Heat Up Time (if required): _____ Hours	Flow rate: _____ GPH or _____ GPM	Inlet Temperature: _____° F or _____° C	Outlet Temperature: _____° F or _____° C
<b>Other Requirements and Additional Heat Loss Considerations:</b> Please attach sheet for additional information			
<b>"AB" FLANGED HEATER</b> Please complete this section to receive a quote for a flanged heater to replace your current screw plug application.			
Replaces Screw Plug Size:	<input type="checkbox"/> 2" NPT <input type="checkbox"/> 2 1/2" NPT <input type="checkbox"/> 3" NPT	Compact Required:	<input type="checkbox"/> Yes <input type="checkbox"/> No
Flange Material:	<input type="checkbox"/> Steel <input type="checkbox"/> Stainless Steel	Pressure Rating:	<input type="checkbox"/> 150 PSI <input type="checkbox"/> 300 PSI <input type="checkbox"/> Other: _____
Tank Adaptor:	<input type="checkbox"/> Yes <input type="checkbox"/> No	Material: <input type="checkbox"/> Steel <input type="checkbox"/> Stainless Steel	Length: _____"
	<input type="checkbox"/> Fixed <input type="checkbox"/> Rotating	<input type="checkbox"/> Square Cut <input type="checkbox"/> Threaded	

To place your order or for technical support, please call TOLL FREE 877-399-HEAT (4328) or FAX 401-245-9331 or check our web site: www.warrenonline.com

# AN ISO 9001 REGISTERED MANUFACTURER

## ELECTRIC PROCESS HEATERS FOR INDUSTRY

Since 1962, Warren Electric Corporation has been industry's source for high quality standard and custom electric immersion heaters, assemblies and accessories. We offer solutions for nearly any process heater application, from the simple to the demanding. Warren Electric means quality products and total quality service defined by application expertise, quick turnaround, competitive prices, and rapid response to customer needs. Turn to the heat source, Warren Electric, for your next requirement.

**PLEASE CALL TOLL FREE**  
**1-877-399-HEAT (4328)**

**Or visit our website for further information:**

**[www.warrenonline.com](http://www.warrenonline.com)**

### CERTIFICATIONS AND COMPLIANCES

Warren Electric Corporation is an **ISO 9001:2000 registered manufacturer**. As an ISO 9001 registered company, WEC has an established system audited to meet the high quality standards necessary to meet or exceed the expectations of our customers and continuously strive for excellence.

Many of Warren Electric Corporation's products are **UL (Underwriters Laboratories) Listed**. When you choose WEC, you know that your heaters have been built, inspected, and tested in accordance with UL standards.

Our application engineers and technical specialists review and approve all our designs to the latest edition of the **National Electric Code**. Only heaters which pass our rigorous electrical tests, in addition to many other inspections, are approved for shipment to our customers.

Warren Electric Corporation has been accredited with the **ASME "U" and "UM" Stamps** for construction of Pressure Vessels and with The National Board of Boiler and Pressure Vessels "R" Stamp for the repair and alteration of pressure vessels, and to register vessels under Warren Electric Corporation.

As an ASME certified manufacturer, Warren Electric Corporation is able to obtain **CRN (Canadian Registration Numbers)** in the Provinces and Territories of Canada to meet pressure vessel requirements of our customers.

Warren Electric Corporation can provide **"CE" Conformance** for your export products. "CE" safety requirements are required for products sold into the European Union of countries. These requirements declare that the product has been tested and conforms to applicable safety standards and specifications.

Warren Electric Corporation insures that inspection, measuring, and test equipment is calibrated and adjusted to meet required accuracy traceable to the **National Institute of Standards and Technology**.

All our heaters and casings meet the requirements of the **"Buy America" Act**.



## WARREN ELECTRIC CORPORATION

36 Franklin Street, PO Box 86, Warren, Rhode Island 02885-0086 USA

Toll Free: 1-877-399-HEAT (4328) Tel: 401-245-3700 Fax: 401-245-9331

Email: [wec@warrenonline.com](mailto:wec@warrenonline.com) [www.warrenonline.com](http://www.warrenonline.com)

**ISO 9001 REGISTERED**

**ASME ACCREDITED**